

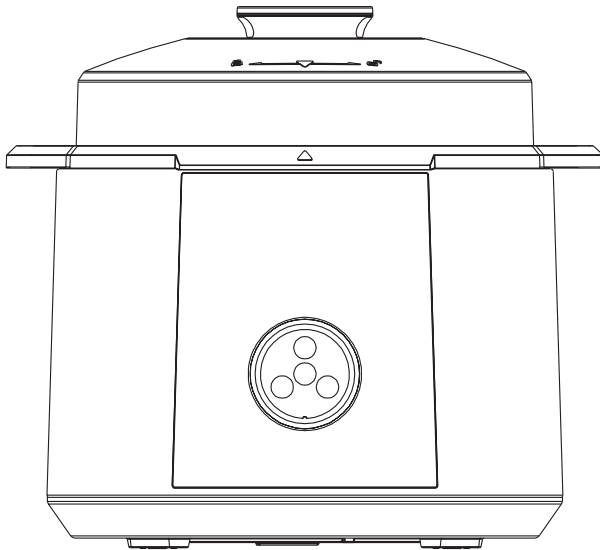

Electric Pressure Cooker

USER MANUAL



MY-CS6022WPA

IMPORTANT NOTE: Please read the manual carefully before operating your product. Retain it for future reference.

(Picture are for reference only, atual product may differ from picture shown)

IMPORTANT PRECAUTIONS

Caution

1. Read all the instructions
2. This appliance is for household use only. Do not use outdoors.
3. This appliance is not intended for use by persons with reduced physical, sensory or mental capabilities, or lack of experience and knowledge, unless they have been given supervision or instruction concerning use of the appliance by a person responsible for their safety.
4. This appliance shall not be used by children. Keep the appliance and its cord out of reach of children;
5. Children should be supervised to ensure that they do not play with the appliance;
6. This appliance is intended to be used in household and similar applications such as:
 - Staff kitchen areas in shops, office and other working environments;
 - farm houses;
 - by clients in hotels, motels and other residential type environments;
 - bed and breakfast type environments;
7. If the supply cord is damaged, it must be replaced by the manufacturer, its service agent or similarly qualified persons in order to avoid a hazard.
8. Please turn off and unplug the appliance before cleaning, maintenance or relocation and whenever it is not in use;
9. Do not immerse any part of the appliance in water or other liquid.
10. The pressure regulator allowing the escape of steam should be checked regularly to ensure that they are not blocked.
11. The container must not be opened until the pressure has decreased sufficiently.

IMPORTANT PRECAUTIONS

Caution

12. The heating element surface is subject to residual heat after use, do not touch.
13. Warning: Avoid spillage on the connector.
14. Warning: Misuse may cause potential injury;
15. The appliance is not intended to be operated by means of an external timer or a separate remote-control system.
16. Do not put the pressure cooker into a heated oven.
17. Move the pressure cooker under pressure with the greatest care. Do not touch hot surfaces. Use the handles and knobs. If necessary, use protection.
18. Do not let children near the pressure cooker when in use.
19. Do not use the pressure cooker for a purpose other than the one for which it is intended.
20. This appliance cooks under pressure. Scalds may result from inappropriate use of the pressure cooker. Make sure that the cooker is properly closed before applying heat, see “instructions for use”.
21. Never force open the pressure cooker. Do not open before making sure that its internal pressure has completely dropped. See the “instructions for use”.
22. Never use your pressure cooker without adding water or food, this would seriously damage it.
23. Do not fill the cooker beyond 2/3 of its capacity. When cooking foodstuffs which expand during cooking, such as rice or dehydrate vegetables, do not fill the cooker to more than half of its capacity.
24. Use the appropriate heat source(s) according to the instructions for use.
25. After cooking meat with a skin (e.g. ox tongue) which may swell under the effect of pressure, do not prick the meat which the skin is swollen; you might be scalded.
26. When cooking doughy food, gently shake the cooker before opening the lid to avoid food ejection.

IMPORTANT PRECAUTIONS

Caution

27. Before each use, check that the valves are not obstructed. See the instructions for use.
28. Never use the pressure cooker in its pressurized mode for deep or shallow frying of food.
29. Do not tamper with any of the safety systems beyond the maintenance instructions specified in the instructions for use.
30. Only use manufacturer's spare parts in accordance with the relevant model. In particular, use a body and a lid from the same manufacturer indicated as being compatible.
31. KEEP THESE INSTRUCTIONS.



The appliance must not be disposed of with regular household waste. At the end of its service life, the appliance must be properly delivered to a collection point for the recycling of electrical and electronic equipment. By Collection and recycling of old appliances, you are making an important contribution to the conservation of our natural resources and provide for environmentally sound and healthy disposal.

Licence holder:

Guangdong Midea Consumer Electric Manufacturing Co., Ltd.
19 Sanle Road, Beijiao, Shunde, 528311 Foshan, Guangdong,
People's Republic Of China

Importer:

Customer service address:

Frequency range: 100-200kHz

Maximum TX power: <25.37dBμA/m at 3m

Hereby, Guangdong Midea Consumer Electric Manufacturing Co.,Ltd , declares that this MY-CS6022WPA is in compliance with the essential requirements and other relevant provisions of RE Directive 2014/53/EU. A copy of the full DoC is attached.

Product Structure

Tips:

1. Please move the product with the handle of the cooker body;
2. Please remove the water from the housing cover with cloth.

Note:

- ① Exhaust valve: Pull out the exhaust valve from the lid. Clean the internal side of the exhaust valve and the exhaust valve and float valve of the lid with brush and cloth at least once a month.
- ② Sealing ring: Please remove oil and dirt from the sealing ring with detergent and brush.
- ③ Water box: After cooking, the steam may stay in the water box of the external pot as water. Water in the box should be removed for avoiding bad odor, please clean it with clean cloth.

Disassemble and install the block proof cover and seal ring

Disassemble and install the block proof cover

Disassemble

Pull it out upwards



Install

Press it down to install



Disassemble and install the seal ring

Disassemble

Pull it out upwards

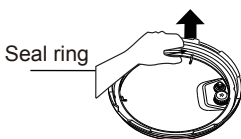

Install

Press it down to install

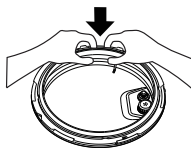

1. Check if the seal ring and block proof cover are correctly installed in the upper cover before use each time.
2. After use, please clean the seal ring and around of block proof cover for avoiding jamming the cover, keep it clean to avoid bad odor.
1. Please do not pull the seal ring, otherwise, the distorted seal ring may influence the seal and pressure effect.
2. Do not use the damaged seal ring, please replace it at the authorized repair office.

Use and maintain the inner pot

1. Do not empty

It may cause yellowish and spotted inner pot or distorted bottom if it is empty for a long time.

2. Do not use it to store the acid, alkali and preserved foods for a long period

Although the inner pot has excellent anti-corrosion performance, it may cause corrosion of certain degree, the suggested time of keep warm shall not exceed 2h.

Use and maintain the inner pot

3. Keep it clean to prolong the service life

Do not immerse it in water for a long period.

Clean the inner pot with soap, mild detergent or warm water to remove dust, oil and dirt.

4. Do not use a metal shovel or other hard tool, otherwise it will damage the inner surface of pot.

Prepare For Cooking

1 Opening the lid correctly

- Hold the handle of upper cover, turn it anticlockwise for about 30° till the lid at unlock state, and then lift the upper cover.

2 Check if the parts and accessories of lid are well installed

- Check if the floater valve and exhaust valve are jammed, confirm if the sealing ring and block proof cover are well installed.

3. Take out the inner pot, put the foods and water into the inner pot

- The total amount of foods and water shall not exceed the Max marked on the inner pot.

4 Put the inner pot into the cooker

- Wipe to clean the external surface of inner pot, foreign object and water are not allowed on the inner surface of electric pressure cooker;
- Turn the inner pot to left and right to ensure good contact with the heating plate.

5 Safely close the lid

- Before closing the lid, check if the sealing ring is well installed.
- Hold the handle of upper cover, aim the lid as "unlock state", put the top cover horizontally on the cooker body, turn the upper cover clockwise for about 30° to the lock place as "Lock State".

6 Put the exhaust valve well

- When working, please turn the exhaust valve to the sealing place, which means the electric pressure cooker keeps at sealing state;
- For manual exhaust, please turn the exhaust valve handle to the exhaust place, the electric pressure cooker keeps at the exhaust state;

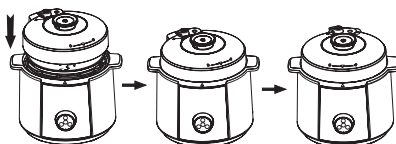
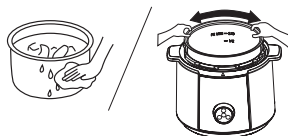
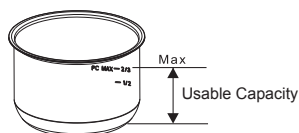
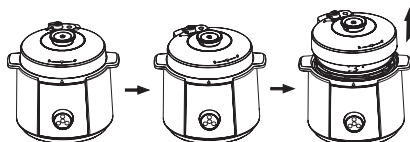

(Picture are for reference only, atual product may differ from picture shown)

Prepare For Cooking

when exhausting, do not keep the hands or face above the exhaust opening;

- Check if the floater valve drops down before working (before heating, the floater valve is down).

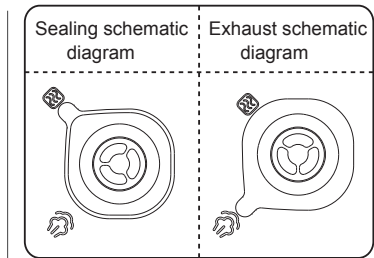

General Function

1. Switch on If the buttons are inactive when use, please confirm if the lid is closed at the right place, the buttons are inactive if the lid is not closed correctly for product of this series.
2. After cooking, the cooker may automatically enter into the keep warm state. After cooking, the cooker may automatically enter into the keep warm state(Some funtion). and the indicator display "0H(0 hour), 1H(1 hour), 2H(2 hour)... "or " L0:00(0 min), L0:01(1 min)...."

Tips:





When the cooker is working, it is normal that it makes "cluck" sound, please set your heart at relax when use.

To cook a small amount of foods, the inner pot may possibly be lifted when opening the lid, please shake the lid to drop the inner pot in the cooker body and then remove the lid.

Safely open the lid

1. Cut off power supply or remove the power plug
2. Exhaust method
 - A. Quickly open the lid (For non-fluid foods)
Turn the exhaust valve to the exhaust place for exhausting, Some unit by pressing steam release button “” till the float valve drops down.
 - B. Generally open the lid
Keep the electric pressure cooker cool naturally till the float valve drops down.
3. Open the lid
Turn the upper cover anticlockwise with the left hand, turn it to the cover open limit place, lift the upper cover with the right hand to open the lid.
Do not open the lid before the pressure in the pot has been completely released, do not open the lid fiercely if it is difficult to open.
Do not pull out the exhaust valve when turning the exhaust valve.
After cooking fluid foods (porridge and soup), do not turn the exhaust valve or press the steam release button please cut off power supply to make it cool naturally till the float drops before opening the lid.

Technical Data Of The Product

Model	Capacity	Power Supply	Rated Power	Size of Inner Pot	Working Pressure	Keep Warm Temperature
MY-CS6022WPA	5.5 L	220-240V~50/60Hz	1100W	8.66"	80kPa	140° F~176° F
Accessories	Spoon 	Soup Spoon 	User Manual 	Measuring cup 	Power Cord Components 	

Product Structure

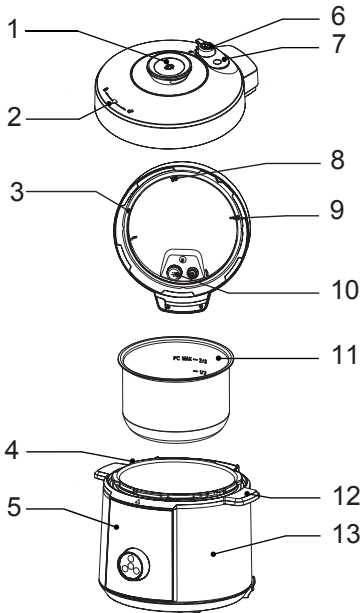





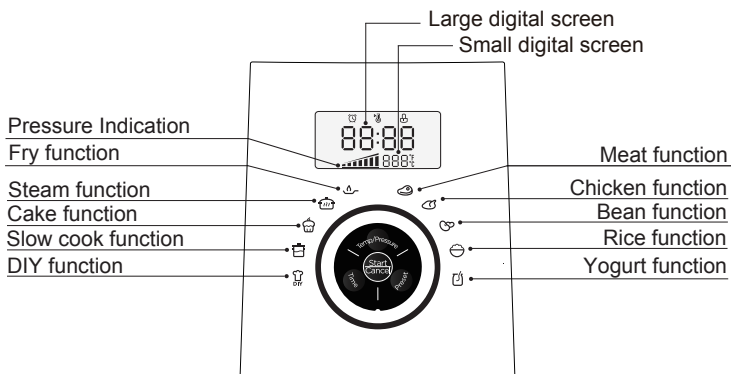

No.	Description
1	Steam release key
2	Lid open/close mark
3	Seal ring
4	Water box
5	Control Box
6	Exhaust opening
7	Float valve
8	Seal ring bracket
9	Sealing gate
10	Block proof cover
11	Inner pot
12	Cooker body handle
13	Cooker body



Operation Part





Function Selection

Function	Operation Guidelines
Cancel	<p>Press and hold the “Start/Cancel” button for 2 seconds to exit the current working status and return to standby state.</p>
 Meat  Chicken  Bean  Steam  Rice	<ol style="list-style-type: none"> 1. Normal cooking: Turn the knob to the corresponding menu icon and icon light flashes, the timer digital screen displays the default pressure working time (Rice function displays “----”) and pressure level, Press the “Start/Cancel” button to start cooking, When the pressure rises to working pressure, the timer digital screen displays the pressure-holding count down time. When the countdown is completed, the cooking finishes and enters into keep warm state. 2. Preset cooking: Before the product starts cooking, press the “Preset” button, the timer digital screen displays the default preset time. Turn the knob to adjust the timer, and press the “Start/Cancel” button to start the preset cooking. When the countdown is completed, the cooking starts. 3. Pressure adjust: Before the product starts cooking, press the “Temp/Pressure” button, the pressure digital screen displays the default pressure level and flashes. Turn the knob to adjust the pressure level, and press the “Start/Cancel” button to start the cooking. 4. Timer adjust: Before the product starts cooking, press the “Timer” button, the timer digital screen displays the default working time and flashes. Turn the knob to adjust the timer as you want, and press the “Start/Cancel” button to start the cooking.
 Cake	<ol style="list-style-type: none"> 1. Normal cooking: Turn the knob to the corresponding menu icon and icon light flashes, and the digital screen displays the default working time and temperature, Press the “Start/Cancel” button to start cooking, the timer digital screen displays the countdown time. When the countdown is completed, the cooking finishes and enters into keep warm state. 2. Timer adjust: Before the product starts cooking, press the “Timer” button, the digital screen displays the default working time and flashes. Turn the knob to adjust the timer as you want, and press the “Start/Cancel” button to start the cooking. 3. Temperature adjust: Before the product starts cooking, press the “Temp/Pressure” button, the temperature digital screen displays the default temperature and flashes. Turn the knob to adjust the temperature as you want, and press the “Start/Cancel” button to start the cooking.

Function Selection

Function	Operation Guidelines
 Yogurt	<ol style="list-style-type: none"> 1. Normal cooking: Turn the knob to the corresponding menu icon and icon light flashes, the timer digital screen displays the default working time, Press the “Start/Cancel” button to start cooking, the timer digital screen displays the countdown time. When the countdown is completed, the cooking finishes and enters into standby state. 2. Timer adjust: Before the product starts cooking, press the “Timer” button, the digital screen displays the default working time and flashes. Turn the knob to adjust the timer as you want, and press the “Start/Cancel” button to start the cooking.
 Slow cook	<ol style="list-style-type: none"> 1. Normal cooking: Turn the knob to the corresponding menu icon and icon light flashes, the timer digital screen displays the default working time, Press the “Start/Cancel” button to start cooking, the timer digital screen displays the countdown time. When the countdown is completed, the cooking finishes and enters into keep warm state. 2. Preset cooking: Before the product starts cooking, press the “Preset” button, the timer digital screen displays the default preset time. Turn the knob to adjust the timer, and press the “Start/Cancel” button to start the preset cooking. When the countdown is completed, the cooking starts. 3. Temperature adjust: Before the product starts cooking, press the “Temp/Pressure” button, the temperature digital screen displays the default temperature and flashes. Turn the knob to adjust the temperature as you want, and press the “Start/Cancel” button to start the cooking. If you set the temperature below 80 °C (175F), it will enter into standby state when the cooking finished. 4. Timer adjust: Before the product starts cooking, press the “Timer” button, the timer digital screen displays the default working time and flashes. Turn the knob to adjust the timer as you want, and press the “Start/Cancel” button to start the cooking.
 Fry	<ol style="list-style-type: none"> 1. Normal cooking: Turn the knob to the corresponding menu icon and icon light flashes, The digital screen displays the default working time and temperature, Press the “Start/Cancel” button to start cooking, the timer digital screen displays the countdown time when the temperature rises up. And when the countdown is completed, the cooking finishes and enters into standby state.

Operation Guidelines

Function	Operation Guidelines
 Fry	<ol style="list-style-type: none"> 2. Temperature adjust: Before the product starts cooking, press the “Temp/Pressure” button, the temperature digital screen displays the default temperature and flashes. Turn the knob to adjust the temperature as you want, and press the “Start/Cancel” button to start the cooking. 3. Caution: This function must be no lid during cooking, otherwise it will stop cooking and report an error as displaying “Lid”
 DIY	<ol style="list-style-type: none"> 1. Temperature cooking mode: Turn the knob to the corresponding menu icon and icon light flashes, the timer digital screen displays the default working time and the temperature digital screen displays the default working temperature, Press the “Temp/Pressure” button, The temperature digital screen flashes, turn the knob to adjust the temperature as you want, then press the “Start/Cancel” button to start cooking, the timer digital screen displays the countdown time during temperature rises up. When the countdown is completed, the cooking finishes and enters into keep warm state. 2. Pressure cooking mode: Before the product starts cooking, Press the “Temp/Pressure” button again to turn into pressure cooking mode, then turn the knob to adjust the pressure level as you want, and press the “Start/Cancel” button to start cooking, the timer digital screen displays the countdown time during pressure rises up. When the countdown is completed, the cooking finishes and enters into keep warm state. 3. Remarks: Temperature cooking mode and pressure cooking mode cannot be selected at the same time; If you set the temperature below 80 °C(175F), it will enter into standby state when the cooking finished. 4. Preset cooking: Before the product starts cooking, press the “Preset” button, the timer digital screen displays the default preset time. Turn the knob to adjust the timer, and press the “Start/Cancel” button to start the preset cooking. When the countdown is completed, the cooking starts. 5. Timer adjust: Before the product starts cooking, press the “Timer” button, the timer digital screen displays the default working time and flashes. Turn the knob to adjust the timer as you want, and press the “Start/Cancel” button to start the cooking.
Temperature units change	In standby state, long press “Temp/Pressure” button for 5 seconds to change the temperature unit as “°C” or “F”

Daily Check And Maintenance









For use the product safely with a longer service life, please carefully check and maintain it.

If followings occur	Solutions
<ul style="list-style-type: none"> • Power cord and plug is expanded, deformation, damaged and it color is changed. • One part of the power cord and plug are hotter. • Power cord is flexible with discontinuous power supply. • The electric pressure cooker has abnormal heating and generates bad odor. • There's abnormal noise or vibration when supply power. 	Stop using, and repair it by the authorized repair center.
<ul style="list-style-type: none"> • There's dust or dirt on the plug or socket. 	Remove the dust or dirt.

Safety Precautions

To avoid personal injury and property loss, be sure to observe the following safety precautions.

• Meanings of the marks:

 Means "Forbidden" items	 General Forbid	 Disassemble Forbidden	 Wet hands Forbidden
	 Contact Forbidden	 Spray Water Forbidden	
 Means "Mandatory" items	 Must be executed	 Remove the power plug	

• The danger caused by mistaken use if following warnings are neglected includes to two grades

 **Warning** | It may possibly cause death or serious injury if the warning items are disobeyed.

 **Caution** | It may cause physical injury or property damage if the caution items are disobeyed.

Safety Precautions

 **Warning**

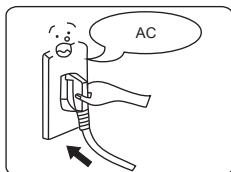

Use correct power outlet (Refer to the label)

- Failure to use correct electricity can cause fire or electric shock.
- Danger of fire if the bad socket is adopted.



Safety Precautions

⚠ Warning

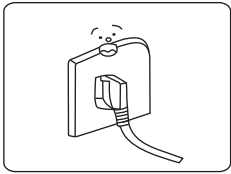

A socket shall be used alone

- A socket of more than 10A rated current with ground-wire shall be used alone;
- If shared with other electrical appliances, the socket may cause abnormal heat and result in fire.

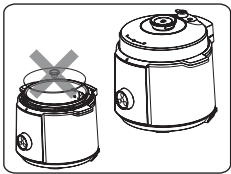

It is strictly prohibited to use other lid

- It is strictly prohibited to use other lid for heating, and in the (switching on) process, the use of non-original lid is not allowed.
- As this may cause electric shock or safety hazards.

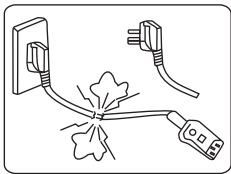

Stop using if the power cord is damaged

- Replace the damaged power cord with special soft cord or replace it with special assembly purchased from the manufacturer or authorized repair center.

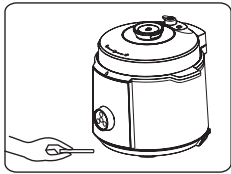

Do not put foreign objects

- It is prohibited to insert metal shavings, needles and other foreign matter in the gap.
- As this may cause electric shock or movement anomalies.

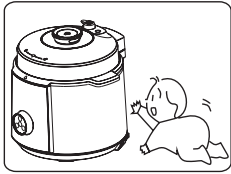

Place the appliance in a location out of reach of infants

- Place the appliance in a location out of reach of infants.
- To avoid electric shock and scald.

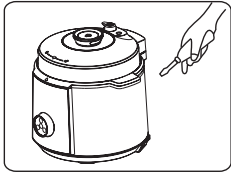

Modification is prohibited

- Modification or repair by non-professionals is prohibited.
- Violation may cause a fire or electric shock.
- Repair or replacement of parts shall be made in a designated service center.

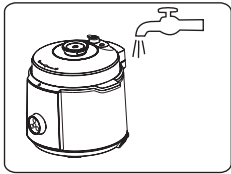

Products may not be immersed or sprinkled in water

- Doing so could cause electric shock and electrical short circuits.



Safety Precautions

⚠ Warning

Warning on Opening the lid

- When the electric pressure cooker is not working, there isn't pressure in the pot, the float valve is down;
- When the electric pressure cooker is working, pressure in the cooker rises, float valve ascends; do not fiercely open the lid before the pressure has been completely released;
- If it is difficult to open the lid, please do not open it fiercely, otherwise, it may cause scalding or physical injury.

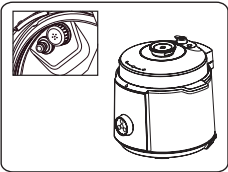

Check periodically

- Be sure to check periodically the block proof cover and exhaust valve core to make sure that they are not be blocked;
- Do not cover the exhaust valve with heavy object or replace it with other object.



⚠ Caution

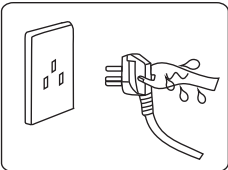

Never pull the plug with a wet hand

- To avoid electric shock.

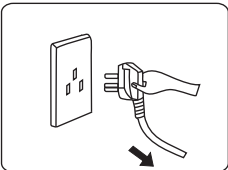

When pulling the plug, you must pinch the plug

- When pulling the plug, you must pinch the plug;
- Do not pull the power cord, otherwise it will damage the cord, causing electric shock and short circuit.

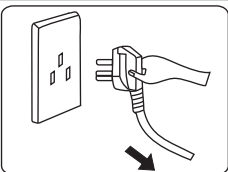

Unplugging when not in use

- Otherwise, it may produce leakage, fire or failure.

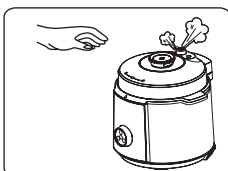

In working, never move your hands to close to the exhaust port.

- In cooking process, never move your hands to close to the exhaust port to avoid burns.
- During cooking, do not cover the vent with a cloth and other items.



Safety Precautions

Caution

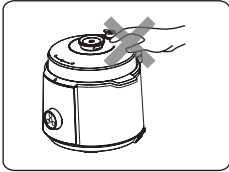

When the cooker is working, please do not touch the lid 

- When the cooker is working, lid has high temperature, do not touch it;
- Otherwise, it may possibly cause scalding.

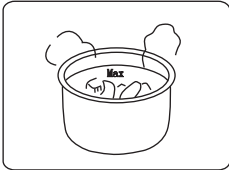

The total amount of food and water can not exceed Max scale

- The total amount of food and water can not exceed Max scale, otherwise food may be cooked unfamiliar, or cause malfunction.

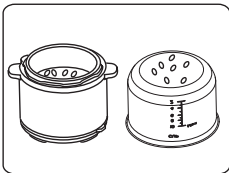

Do not use a pot other than the dedicated pot 

- When there is foreign object on the bottom of pot and heating plate surface, remove the foreign object before use.
- Otherwise, it may cause overheating and work abnormalities etc.

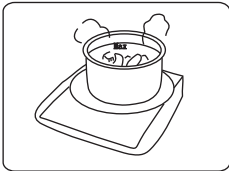

Do not put the inner pot on other appliance for heating 

- In order to avoid deformation or fault.
- Please use the special inner pot.

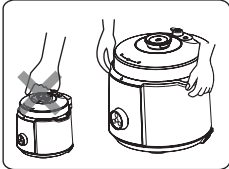

When moving the product, please hold the handle of cooker body 

- When moving the product, do not directly hold the handle of lid for avoiding lid dropping.

Do not use in the following locations 

- Do not use in unstable locations;
- Do not use in locations near water and fire;
- Do not use near walls and furniture;
- Do not use in locations exposed to direct sunlight and oil splatter.
- Do not approach the stove for avoiding fire.

Environment For Storing The Product

- Periodically clean the cooker and remove oil and dirt if it is stored on the table.
- Put the electric pressure cooker 30cm away from other kitchen appliances.

Clean After Use

1. Clean after each use.
2. Before cleaning and maintenance, please unplug the power cord until the product cools.
3. Remove the lid and inner pot, clean with detergent first, then rinse well with water, and wipe dry with a soft cloth.
4. Clean the internal side of the lid with water, the seal ring, block proof cover, exhaust valve core and float valve can be removed for washing, timely and correctly install them after washing, and then dry the internal side of lid with cloth.
5. Wipe clean the cooker body with a rag, and it is prohibited to soak the cooker body in water or spray water to it.

Troubleshooting

When followings occur, it is not the cooker fault, please carefully check once before sending it for repair.

S/N	Problem	Reason	Solution
1	Difficult to close the lid	Sealing ring not installed properly	Position the sealing ring well
		The floater valve clamps the push rod	Lightly push the push rod
2	Difficult to open the lid	Float valve in the popped-up position	Press the float valve lightly with a chopstick.
		Pressure exists inside the cooker	Open the lid after the pressure is completely released.
3	Steam leaks from the lid	Sealing ring installed improperly	Install the sealing ring as required
		Food debris attached to the sealing ring	Clean the sealing ring
		Sealing ring damaged	Replace the sealing ring
		The lid is not closed correctly	Close the lid correctly
4	Steam leaks from float valve	Food debris on the float valve gasket	Clean the float valve gasket
		Float valve gasket worn-out	Replace the float valve gasket
5	Float valve unable to rise	Too little food and water in inner pot	Add water and food according to the recipe
		Steam leaks from the lid or exhaust valve	Send to the service center for repair
6	Steam comes out from exhaust valve non-stop	Exhaust valve not in sealing position	Turn the exhaust valve to the sealing position
		Pressure control fails	Send to the service center for repair

Troubleshooting

S/N	Problem	Reason	Solution	
7	Power indicator doesn't light on	Power socket bad contact	Please check the power socket	
8	Rice half cooked or too hard	Bottom sensor fault	Add water accordingly	
		Lid opened prematurely	After cooking cycle completes, leave the lid on for 5 more minutes.	
9	Rice too soft	Too much water	Reduce water accordingly	
10	All indicators flas	Display screen displays E1	Bottom sensor open circuit	
		Display screen displays E5	Sensor on the lid open circuit	
		Display screen displays E6	Sensor on the lid short circuit	
		Display screen displays E8	Pressure switch fault	
		Display screen displays E11	Control PCB and Launch PCB communication fault	
		Display screen displays E12	Receive PCB and Launch PCB communication fault	
		Display screen displays E13	Float sensor open/short circuit	
		Display screen displays E14	Float sensor correction fault	
		Display screen displays E15	Temperature sensor on Receive PCB fault	
		Display screen displays E17	Receive PCB fault	
		Display screen displays E18	Launch PCB fault	
		Display screen displays Pot	There is no pot	Put it into the pot
		Display screen displays Lid	The lid is on the error position	Placed in the right position
Display screen displays E30	After pressure test can't cover	After press launch abnormal communication between plate and receiving plate, undetectable on the cover		

—If the fault is not removed after above check, please contact our authorized service center for repair.

Any other servicing should be performed by an authorized service representative.