

Cooker Hood

USER MANUAL

CXW-220-B82

Warning notices: Before using this product, please read this manual carefully and keep it for future reference. The design and specifications are subject to change without prior notice for product improvement. Consult with your dealer or manufacturer for details. The diagram above is just for reference. Please take the appearance of the actual product as the standard.

THANK YOU LETTER

Thank you for choosing Midea! Before using your new Midea product, please read this manual thoroughly to ensure that you know how to operate the features and functions that your new appliance offers in a safe way.

CONTENTS







THANK YOU LETTER	01
SAFETY INSTRUCTIONS	02
SPECIFICATIONS	04
PRODUCT OVERVIEW	05
PRODUCT INSTALLATION	06
OPERATION INSTRUCTIONS	07
CLEANING AND MAINTENANCE	09
TROUBLE SHOOTING	11
TRADEMARKS, COPYRIGHTS AND LEGAL STATEMENT	12
DISPOSAL AND RECYCLING	13
DATA PROTECTION NOTICE	14

SAFETY INSTRUCTIONS

Intended Use

The following safety guidelines are intended to prevent unforeseen risks or damage from unsafe or incorrect operation of the appliance. Please check the packaging and appliance on arrival to make sure everything is intact to ensure safe operation. If you find any damage, please contact the retailer or dealer. Please note modifications or alterations to the appliance are not allowed for your safety concern. Unintended use may cause hazards and loss of warranty claims.

Explanation of Symbols

	Danger This symbol indicates that there are dangers to the life and health of persons due to extremely flammable gas.
	Warning of electrical voltage This symbol indicates that there is a danger to life and health of persons due to voltage.
	Warning The signal word indicates a hazard with a medium level of risk which, if not avoided, may result in death or serious injury.
	Caution The signal word indicates a hazard with a low degree of risk which, if not avoided, may result in minor or moderate injury.
	Attention The signal word indicates important information (e.g. damage to property), but not danger.
	Observe instructions This symbol indicates that a service technician should only operate and maintain this appliance in accordance with the operating instructions.

Read these operating instructions carefully and attentively before using/commissioning the unit and keep them in the immediate vicinity of the installation site or unit for later use!

WARNING

- This appliance is not intended for use by persons (including children) with reduced physical, sensory or mental capabilities, or lack of experience and knowledge, unless they have been given supervision or instruction concerning use of the appliance by a person responsible for their safety. Children shall not play with the appliance.
- Cleaning and user maintenance shall not be made by children without supervision. If the supply cord is damaged, it must be replaced by the manufacturer, its service agent or similarly qualified persons in order to avoid a hazard. There shall be adequate ventilation of the room when the range hood is used at the same time as appliances burning gas or other fuels.
- Please do not use corrosive detergent for cleaning. The proper function of the unit is conditioned by the regularity of the maintenance.
- To protect the main body from corrosive of the long time accumulation of dirt, the cooker hood should be cleaned with hot water with non-corrosive detergent every two months.
- There is a fire risk if cleaning is not carried out in accordance with the instructions.
- Do not flame under the range hood.
- The air must not be discharged into a flue that is used for exhausting fumes from appliances burning gas or other fuels.
- The minimum distance between the supporting surface for the cooking vessels on the hob and the lowest part of the range hood. This distance shall be at least 65 cm. If the instructions for installation specify a smaller distance, this has to be taken into account. The distance of 65 cm can be reduced for: non-combustible parts of range hoods, except grease filters, and parts operating at safety extra low voltage, provided these parts do not give access to live parts if deformed.
- Regulations concerning the discharge of air have to be fulfilled.
- The appliance uses 4 hob elements at most.
- CAUTION :Accessible parts may become hot when used with cooking appliances.
- Lamp information.

	Max Power	Voltage	Picture	Lamp Cap
Square/Diameter: 120x33.2mm	1.5W	DC 12V		--

- This appliance can be used by children aged from 8 years and above and persons with reduced physical, sensory or mental capabilities or lack of experience and knowledge if they have been given supervision or instruction concerning use of the appliance in a safe way and understand the hazards involved. Children shall not play with the appliance. Cleaning and user maintenance shall not be made by children
- without supervision.
The appliance is not intended for use by young children or infirm persons without
- supervisions.
- Young children should be supervised to ensure they do not play with the appliance.
- Plug the power cord to socket outlet with earthing continuity terminal.

- The cooker hood is for home use only, not suitable for barbecue, roast shop and other commercial purposes.
- The cooker hood and its filter should be cleaned regularly according to the instruction.
- Do not use open flame, or allow oil to go beneath the appliance.
- If there is any fault occurred with the appliance, please call after-sale service department.
- Please keep the kitchen room ventilated.
- Prior to any maintenance, cleaning operation, ensure the power is cut off.
- If the supply cord is damaged, it must be replaced by the manufacturer, service agent or similarly qualified person in order to avoid a hazard. The replaced power cord should be provided by manufacturer or seller.
- If the plug or cord is damaged, please call after-sale service center.
- There is a fire risk if cleaning is not carried out in accordance with the instruction.
- In case of damaged connecting wire, please refer to the manufacturer, after-sale service personnel or other qualified technicians.
- Use the unit according to the instructions to avoid any fire hazard.
- The exhaust air must not be introduced into a smoke flue or chimney that is used for exhausting fumes from appliances burning gas.
- Follow the local laws applicable for external air evacuation.
- Range hoods and other cooking fume extractors may adversely affect the safe operation of appliances burning gas or other fuels (including those in other rooms) due to back flow of combustion gases. These gases can potentially result in carbon monoxide poisoning. After installation of a range hood or other cooking fume extractor, the operation of flued gas appliances should be tested by a competent person to ensure that back flow of combustion gases does not occur.

SPECIFICATIONS

Model	CXW-220-B82
Voltage	220-240V-
Frequency	50Hz
Rated power	223W
Lighting power	1.5W × 2
Motor input power	220W
Diameter of air tube	180mm
Noise	≤69dB(A)

The air flow parameter is tested under conditions of 230V-/50Hz when the voltage is 220V-240V-/50Hz.

PRODUCT OVERVIEW

Components

Ref.	Qty.	Product Components
1	1	Range hood body
2	1	Exhaust pipe
3	1	Installation plate
4	1	Oil cup
5	1	Screws M5x16
6	6	Screw M5x50
7	7	Expansion bolt
8	2	Self tapping screw ST4.2x9.5
9	1	Chimney fixing bracket
10	1	Limited block
11	1	Screw M5x45
12	2	Screw ST2.9x9.5
13	4	Screw ST4.2x16
14	1	Pipe adapter (optional)

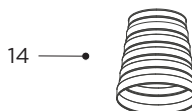
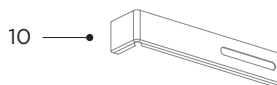
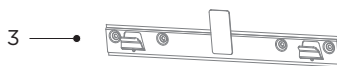
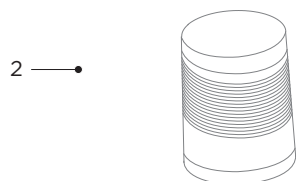
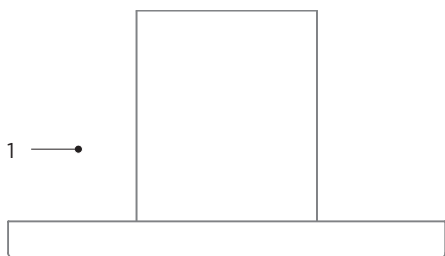

PRODUCT INSTALLATION

Determine location

- Range hood should be installed horizontally on the top of the stove, the installation diagram is as follows:

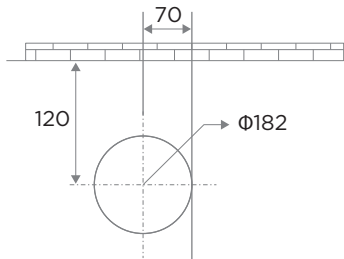
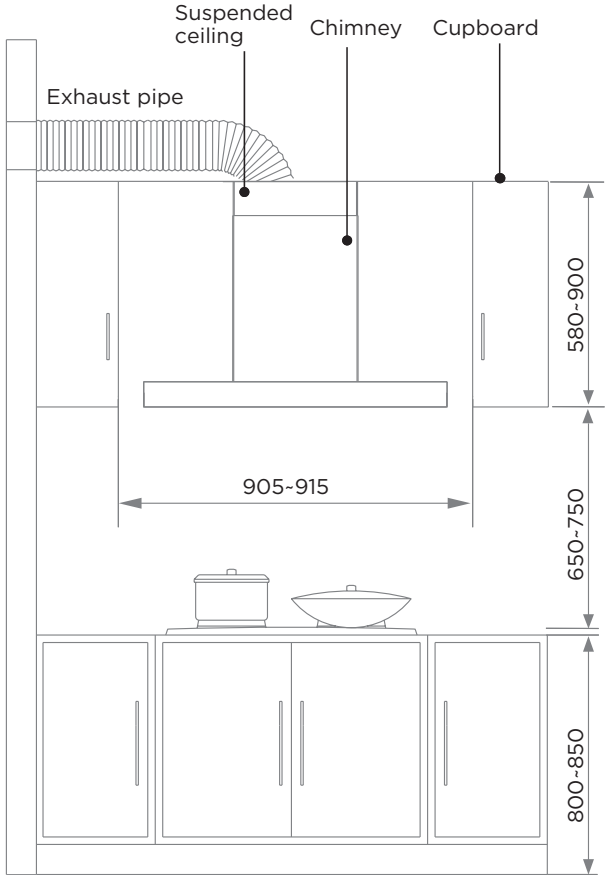

Schematic diagram of the hole size of the exhaust pipe at the ceiling.

Installation plate

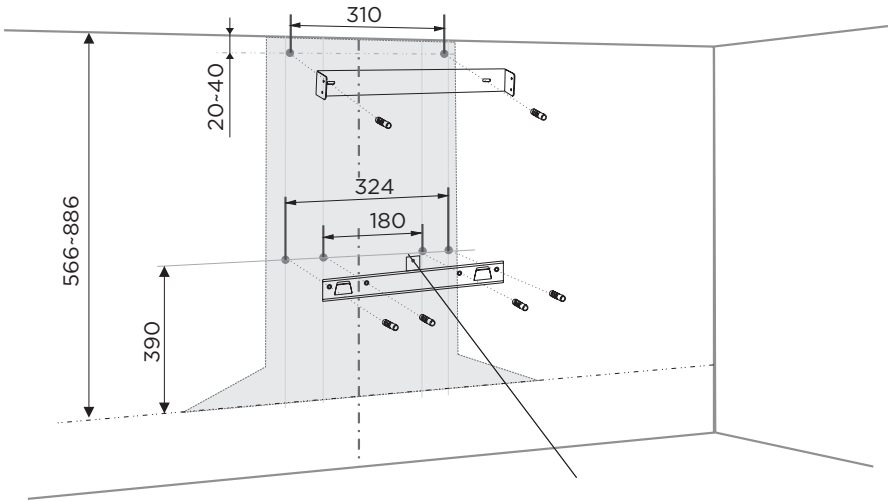





WARNING

Failure to install the screws or fixing device in accordance with these instructions may result in electrical hazards.

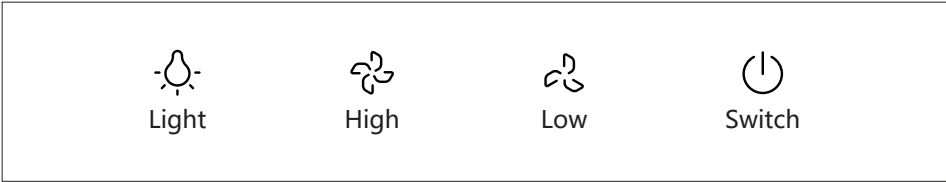
OPERATION INSTRUCTIONS

Range Hood Can Be Used After Power.



Button	Name	Function
	Light	Press: Turn on the light.
	High speed	Turn on the power; Press High speed : Turn on high speed ; Press Low speed : Turn on low speed. (Two patterns can't run at the same time)
	Low speed	
	Switch	1 st Short press: Start up (speed); 2 nd Short press: Delay 3 min; 3 rd Short press: OFF immediately.

CLEANING AND MAINTENANCE

Surface cleaning

- Recommendation after cooking with a dry cloth or a wet cloth moistened with neutral surfaces of the machine. Do not use clean balls, brushes or coarse cloth to avoid scratching the machine surface.
- Oil cup installation:
The cup holder into the buckle in the air inlet hood, return the oil cup horizontally with both hands.
- Oil cup disassemble:
Hold the oil cup edge with both hands, move it.
- Suggestion:
Clean the air inlet hood every 2 weeks or no less than every month.
- How to clean:
 - 1.Unsrew the air inlet hood and take it out.
 - 2.Put the hood into warm water with neutral detergent.
 - 3.Clean it with a soft brush.
 - 4.Mounting it when it s dried.
 - 5.Install the air inlet hood.

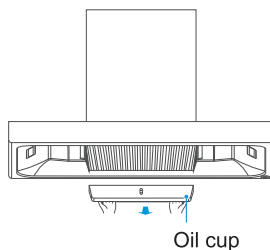

Internal Cleaning

1. Unplug the power cord, unscrew the screws for fixing cover.

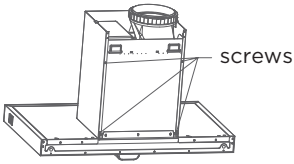

2. Remove the decorative cover.

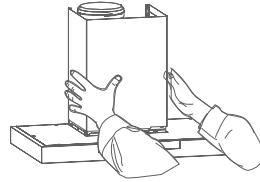

3. Remove screw, take down the rack cover plate.

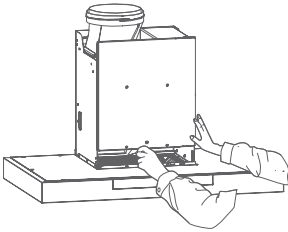

4. Remove screw, take down the air inlet ring.

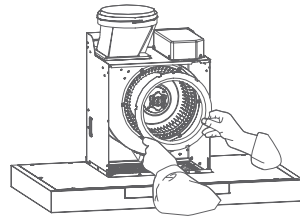

5. Loose the nut according to instruction, take out the impeller.

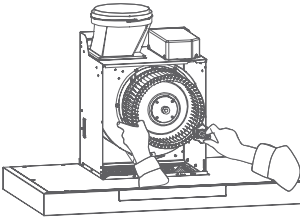

6. Clean the impeller and volute with neutral detergent, install them according to reverse order of disassembly.



Safety Caution

Dismantle the filter to clean the impeller and volute, needs to be completed by professionals.

TROUBLE SHOOTING

Fault	Solution
Both light and motor do not work	Unplug power plug and reconnect the power supply.
Oil leakage	Oil cup tilt, please reinstall.
	Oil cup full filled with oil, please dump the oil.
	Oil-way blockage caused by long time uncleaned internal oil-way, needs professionals to wash the hood.
Insufficient suction	Avoid opening window or door frequently.
	Adjust to max. speed.
Loud noise	Reinstall the exhaust pipe properly.
	Ensure firm installation.

TRADEMARKS, COPYRIGHTS AND LEGAL STATEMENT

 Midea logo, word marks, trade name, trade dress and all versions thereof are valuable assets of Midea Group and/or its affiliates (“Midea”), to which Midea owns trademarks, copyrights and other intellectual property rights, and all goodwill derived from using any part of an Midea trademark. Use of Midea trademark for commercial purposes without the prior written consent of Midea may constitute trademark infringement or unfair competition in violation of relevant laws.

This manual is created by Midea and Midea reserves all copyrights thereof. No entity or individual may use, duplicate, modify, distribute in whole or in part this manual, or bundle or sell with other products without the prior written consent of Midea.

All the described functions and instructions were up to date at the time of printing this manual. However, the actual product may vary due to improved functions and designs.

DISPOSAL AND RECYCLING

Important instructions for environment

Compliance with the WEEE Directive and Disposing of the Waster Product:
This product complies with EU WEEE Directive (2012/19/EU). This product bears a classification symbol for waster electrical and electronic equipment (WEEE).

This symbol indicates that this product shall not be disposed with other household wastes at the end of its service life. Used device must be returned to official collection point for recycling of electrical electronic devices. To find these collection systems please contact to your local authorities or retailer where the product was purchased. Each household performs important role in recovering and recycling of old appliance. Appropriate disposal of used appliance helps prevent potential negative consequences for the environment and human health.



Compliance with RoHS Directive

The product you have purchased complies with EU RoHS Directive (2011/65/EU). It does not contain harmful and prohibited materials specified in the Directive.

Package information

Packaging materials of the product are manufactured from recyclable materials in accordance with our National Environment Regulations. Do not dispose of the packaging materials together with the domestic or other wastes. Take them to the packaging material collection points designated by the local authorities.

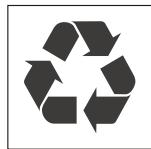

DATA PROTECTION NOTICE

For the provision of the services agreed with the customer, we agree to comply without restriction with all stipulations of applicable data protection law, in line with agreed countries within which services to the customer will be delivered, as well as, where applicable, the EU General Data Protection Regulation (GDPR).

Generally, our data processing is to fulfil our obligation under contract with you and for product safety reasons, to safeguard your rights in connection with warranty and product registration questions. In some cases, but only if appropriate data protection is ensured, personal data might be transferred to recipients located outside of the European Economic Area.

Further information are provided on request. You can contact our Data Protection **Officer via MideaDPO@midea.com**. To exercise your rights such as right to object your personal data being processed for direct marketing purposes, please contact us via **MideaDPO@midea.com**. To find further information, please follow the QR Code.



make yourself at home



www.midea.com

16173000AXXXXX

V1.0