

The diagram above is just for reference. Please take the appearance of the actual product as the standard.

WATER PURIFIER

# Instruction Manual

Model: JL1850S-RO

Before installing and operating your water purifier, please read the instruction manual carefully and keep it for future reference.

# DIRECTORY

<b>1. Precaution</b> .....	1
1-1 Safety Issues .....	1
1-2 Packing List .....	2
<b>2. Your Direct Drinking Water Purifier</b> .....	2
2-1. Part Name of Water Purifier.....	2
2-2. Model and Major Parameters .....	3
2-3. Product Features.....	3
2-4. Working Principle .....	4
<b>3. Use Guide and Maintenance</b> .....	5
3-1. Guidance on Unpacking and Installation .....	5
3-2. Machine Installation .....	7
3-3. The display panel is shown as below:.....	7
3-4. Maintenance .....	8
3-5. Troubleshooting .....	9
<b>4. 1 Year Limited Warranty</b> .....	10

The packaging material used is recyclable; we recommend that you separate plastic, paper and cardboard and give them to recycling companies. To help preserve the environment, the refrigerant used in this product is R134a (Hydrofluorocarbon -HFC), which does not affect the ozone layer and has little impact on the greenhouse effect. Guidelines, waste from electrical and electronic devices should be collected separately. If you need to dispose of this appliance in the future, do NOT throw it away with the rest of your domestic garbage.



## 1. Precaution

### 1-1 Safety Issues

Please note the following brief icons and rules for safe use of this product



#### Troubleshooting

When the machine fails, please disconnect the power and water source immediately



#### Maintenance

Never remove the parts on the machine to avoid leakage or damage



#### Avoid contact with children

Never have the machine operated by a child



#### Temperature

Please use the product in a dry place with the temperature of 4-43°C



#### Electricity prevention

To avoid leakage of electricity.



#### Accessories and filters

To maintain the normal operation of the machine, be sure to use accessories and filters supplied by original company



#### Emergency call

For any help, please call the local sale service center or the national service hotline



#### Correct repair service

This machine can only be repaired by qualified personnel designated by this company



#### Avoid direct sunshine

Do not install the machine in a place exposed to direct sunshine















#### Anti-freeze

Never store or expose the product duct in an environment less than 0°C

1. This appliance can be used by children aged from 8 years and above and persons with reduced physical, sensory or mental capabilities or lack of experience and knowledge if they have been given supervision or instruction concerning use of the appliance in a safe way and understand the hazards involved. Children shall not play with the appliance. Cleaning and user maintenance shall not be made by children without supervision.
2. Children should be supervised to ensure that they do not play with the appliance.
3. If the supply cord is damaged, it must be replaced by the manufacturer, its service agent or similarly qualified persons in order to avoid a hazard.
4. Do not store explosive substances such as aerosol cans with a flammable propellant in this appliance.
5. This appliance is intended to be used in household and similar applications such as staff kitchen areas in shops, offices and other working environments; farm houses and by clients in hotels, motels and other residential type environments; bed and breakfast type environments; catering and similar non-retail applications.
6. The appliance is suitable for indoor use only.
7. WARNING: Keep ventilation openings, in the appliance enclosure or in the built-in structure, clear of obstruction.
8. WARNING: Do not use mechanical devices or other means to accelerate the defrosting process, other than those recommended by the manufacturer.
9. The appliance must not be immersed.
10. WARNING: To avoid a hazard due to instability of the appliance, it must be fixed in accordance with the instructions.
11. This product is not recommended to use in areas above 2,000m altitude.
12. WARNING: UV radiation is dangerous for eyes and skin. Do not operate the UV-C emitter outside the appliance.
13. WARNING: Do not operate the UV-C emitter when it is removed from the appliance enclosure;
14. WARNING: This appliance contains a UV emitter. Do not stare at the light source.
15. Unintended use of the appliance or damage to the housing may result in the escape of dangerous UV-C radiation. UV-C radiation may, even in little doses, cause harm to the eyes and skin.
16. Appliance the are obviously damaged must not operated.
17. If the replacement of the UV-C emitter by the user is not allowed, this must be clearly stated.

18. WARNING: When positioning the appliance, ensure the supply cord is not trapped or damaged.
19. WARNING: Do not locate multiple portable socket-outlets or portable power supplies at the rear of the appliance.
20. To ensure the product using well, please make sure the product installation, testing and filter exchange are made by aftersales service person.
21. In order to make sure the machine can be used normally, please keep it stand still for 24 hours before powering up.
22. The new hose-sets supplied with the appliance are to be used and that old hose-sets should not be reused.

## 1-2 Packing List

Instruction Manual(1 copy)	Bracket(1PC)	Screws(2PC)	Crossover sub (1PC)	Filter connector (1PC)	1/4" PE pipe(White)(2m) 1/4" PE pipe(Blue)(2m) 3/8" PE pipe(1m)
					
Snap ring(4PC)	Sealing ring (1PC)	Small sealing plug(1PC)	Large sealing plug(1PC)	Pipe clamp (1PC)	reducing valve(1PC)
					

## 2. Your Direct Drinking Water Purifier

### 2-1. Part Name of Water Purifier

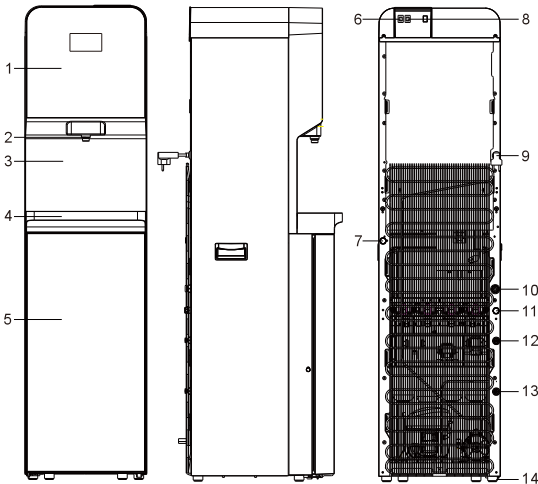

NO.	PART NAME
1	Controls panel
2	Spout
3	Front carapace
4	Water collector
5	Door
6	Heating switch
7	Outlet of cold water
8	Cooling switch
9	Power cord
10	Outlet of the water collector
11	Outlet of hot water
12	Concentrated water connection
13	Water inlet
14	The base

### NOTE:

Please use the product in a place with temperature of 4-43°C and relative humidity less than 85%.

## 2-2. Model and Major Parameters

Model	JL1850S-RO
Rated voltage	220-240V~
Rated frequency	50/60Hz
Rated power	994W
Heating power	874W
Cooling current	1.0A
Rated pure water flow	1.2L/min(0.3MPa)
Hot water capacity	7.5L/h( $\geq 85^{\circ}\text{C}$ )
Cold water capacity	4L/h( $\leq 10^{\circ}\text{C}$ )
Applicable environment	4-43 $^{\circ}\text{C}$ humidity $\leq 85\%$
Applicable water pressure	0.1-0.4MPa
Applicable water	Tap water
	TDS $\leq 350$ ppm
Applicable water temperature	5-38 $^{\circ}\text{C}$
Stage 1	PP sediment filter-F1
Stage 2	C1 active carbon filter-F1
Stage 3	RO reverse osmosis filter-F1
Stage 4	C2 active carbon filter-F1
Product size	360(W)*460(D)*1400(H) mm
Packing size	480(W)*505(D)*1490(H) mm

## 2-3. Product Features

1. Hot & Warm & Cold water , three types of water temperature.
2. Full plate quality toughened glass design, elegant and beautiful.
3. The latest leakage protection device, to ensure the safety of Public environmental.
4. Water tank built-in UV-LED bacteriostatic, to ensure the safety and health of water.
5. Large screen display, working status at a glance.(heating /cooling /filtrating /filter lifetime/UV).

## 2-4. Working Principle

### 1. Flowchart of water generation

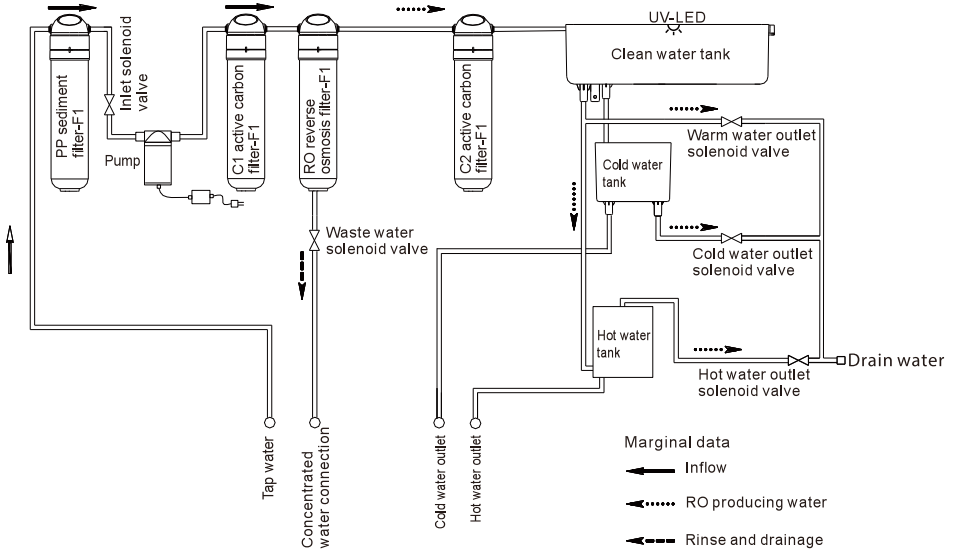

### 2. Circuit diagram

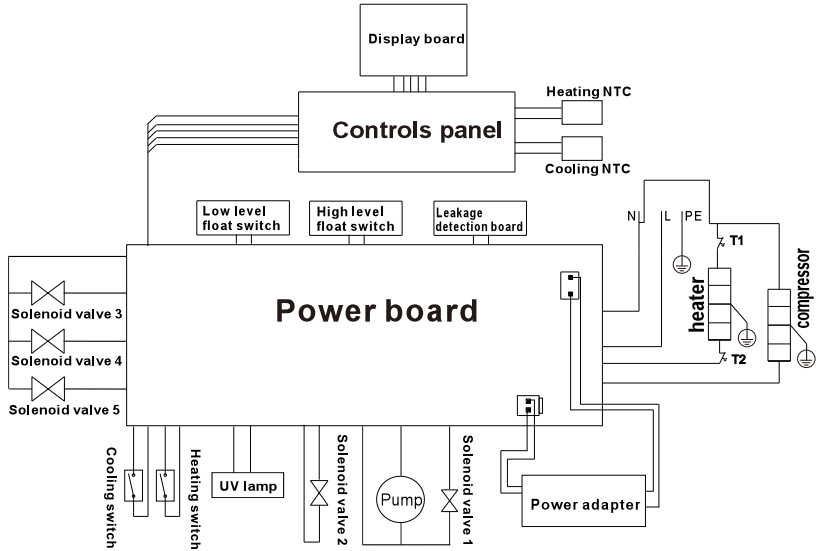

### 3. Filter Function Introduction and Replacement Cycle

Stage	Filter	Function	Replacement Cycle
Stage 1	PP sediment filter-F1	Carry out coarse filtration of original water, and filter out mud, sand, impurity, iron rust and suspension, etc.	3-6 months
Stage 2	C1 active carbon filter-F1	Absorb unusual colors and odors, Remove residual chlorine and organic substances in water.	6-12 months
Stage 3	RO reverse osmosis filter-F1	Nonionic Absorbing: Organics, alcohol, ketone, aldehyde, phenol. Particulate retention: Solid suspended solids, Colloids.	12-24 months
Stage 4	C2 active carbon filter-F1	Further absorb micro-molecules and organic substances in water. Make water taste better.	6-12 months

**Notice:** Filter life time is an expected value, due to different region, water quality, usage and season, the actual lifetime will be different, please follow the advise of the local service station.

### 3. Use Guide and Maintenance

**WARNING:** Please cut off water source before replacing filters. Never plug filters in water running state.

#### 3-1. Guidance on Unpacking and Installation

1. Unpack the product.
2. Put the accessories aside.
3. Take out the quick joint, and install it on the water pipe. Clamps should not be missed.

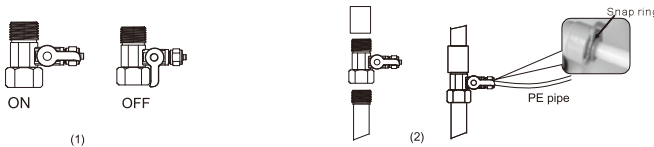

4. Open the lower door .
5. Use the after sale accessory—filter flushing tip, the arrow direction is the water flow direction, insert the PE pipe in the quick joint.

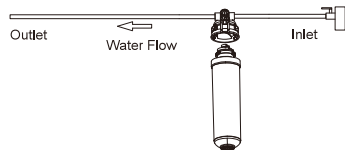

6. Insert the C1 active carbon filter into the filter flushing tip, tighten it by turning anticlockwise, and open the water tap to flush the filter till it doesn't discharge black water, for about 10min; Take the same step to flush the C2 active carbon filter-F1.
7. Install the clean filter in the product, hold the filter with the left hand and enclosure of filter with the right hand, and insert it upwards in the filter, tighten it by turning anticlockwise, the installation order is: PP sediment filter-F1→C1 active carbon filter-F1→RO reverse osmosis filter-F1→C2 active carbon filter-F1. After washing and installation of filters, the lower door must be fixed with original screws.

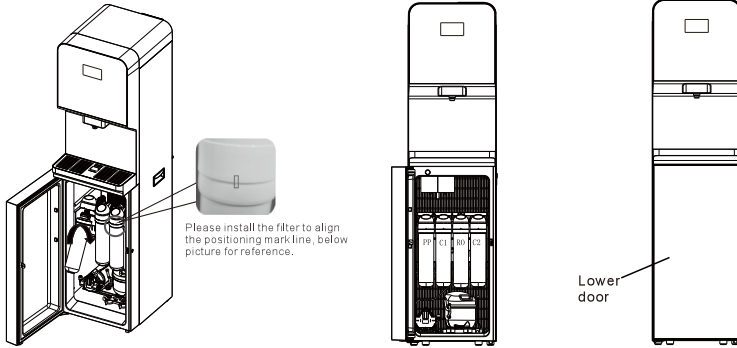

8. Take out the pin of the quick joint at the rear of the products side plate's, and then take out the white plug.

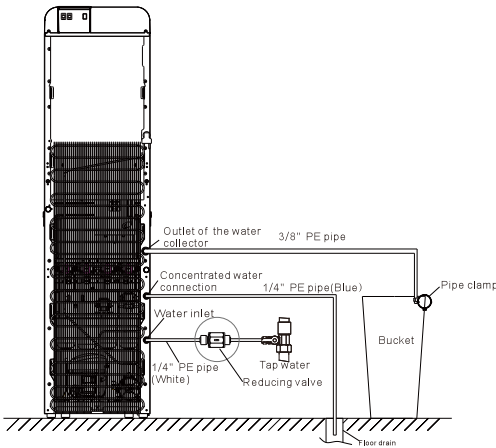

Note: When the tap water pressure exceeds 0.4MPa, it requires installing the pressure relief valve. Keep the water flowing arrow towards the water inlet interface of the machine.

9. Insert the water inlet PE pipe in the quick joint, and tighten the pin. The new hose-sets supplied with the appliance are to be used and that old hose-sets should not be reused.
10. The water cooler plug cord into a ground fault interrupter receptacle.
11. After installation, supply water and power. Discharge the first 3 tanks of purified water by pressing the button, press the Heating and Cooling buttons on the rear panel to purify water again, then the water output is drinkable.
12. When installing filter and replace filter please turn off the water and power supply before installation and replacement.
13. Concentrated water and the water drained from the water tray can be directly discharged into the sewer or the water drained from the water box can also be discharged to the bucket. (Note: Drainage pipe must be vertical and shall not be "U" or twisted at any section)

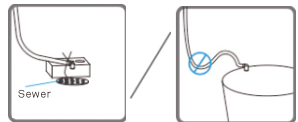



## 14: Water tray discharge treatment

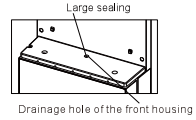
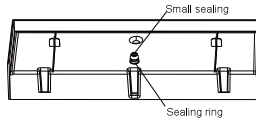
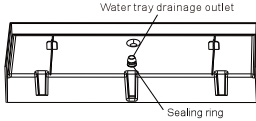

When the water can't be smoothly discharged from the water tray, please install the sealing ring on the drainage outlet slot of the water tray.

If the remaining water in the water tray won't be received with water tank, the big and small sealing plugs shall be adopted.

Step 1, install the small sealing plug in the drainage outlet of the water tray, and ensure installing in place.

Step 2, install the big sealing plug in the drainage hole of the front housing, and then press it in place with the water tray.

## 3-2. Machine Installation



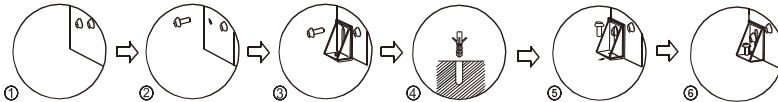
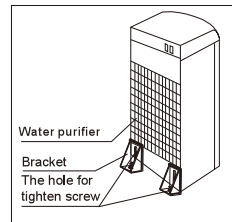



- 1-2. Loosen the screw of the left or right bottom angle just as the picture shown.
3. Use the screw to fix the bracket on the left or right bottom angle of the water purifier.
4. Make a hole on the floor's or the desk's surface where the water dispenser will be installed.
5. Fix the bracket on the floor by screw tightly.
6. Tighten the screw.

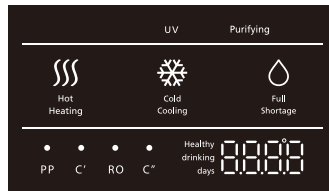

**WARNING!** To avoid a hazard due to instability of the appliance, it must be fixed in accordance with the instructions.

## 3-3. The display panel is shown as below:



1. "  " When displays as this, it indicates that water heating is completed.
2. "  " When displays as this, it indicates that water is heating.
3. "  " When displays as this, it indicates that water cooling is completed.
4. "  " When displays as this, it indicates that water is cooling.
5. "  " It indicates that there's insufficient water in the machine.
6. "  " It indicates that there's sufficient water in the machine.
7. " **Purifying** " When it is on, it indicates that the machine is purifying water.
8. "  " When indicator in this area flashes, it indicates that the filter of corresponding level expires, please replace the filter.

## DISPENSING WATER

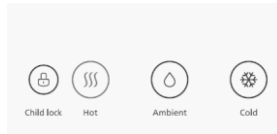

1. Touch the cold water button “❄️”, the device starts discharging cold water; Touch the cold water button “❄️” again, the device stops discharging water, finish getting water.
2. Touch the normal water button “💧”, the device starts discharging normal water; Touch the normal water button “💧” again, the device stops discharging water, finish getting water.
3. Touch the child lock button “🔒”, then touch the hot water button “🌊”, the indicator turns on and the device starts discharging hot water. Touch the anyone button, the device stops discharging water, finish getting water.
4. Long press the cold water button “❄️” + warm water button “💧” for 3 seconds to enter the filter reset mode. The indicator light and name of the first filter flash, and the remaining percentage of filter life displays in the bottom right corner of the screen. Long press the cold water button “❄️” for 3 seconds to reset the filter, and the life of the filter is restored to 100%. Press the cold water button “❄️” to switch to the next filter display, and operate the same to reset and switch to the next filter. When it comes to the last filter, press the cold water button “❄️” to exit the filter reset mode.

### 3-4. Maintenance

1. Keep this machine in a dry and cool place and avoid direct sunshine. Rearward of the machine shall be at least 25 cm away from the wall. Never put the machine on paper or foam, which may store water and then cause creepage. Never put anything flammable beside this machine. Do not use the machine outdoors or in a place that can be splashed by water.
2. For the water purifier, the installation and replacement of filters must be carried out by qualified personnel.
3. In case the machine is not in use for a long time, turn off the heating switch or the refrigerating switch to save power.
4. In case the machine is not needed for a long time, please take off the plug, turn off the copper chrome-plated ball valve and drain off the remaining water through the outlet. For another use, discharge water for 10 min. In the event that the machine is blocked by ice due to the environment below ice point, keep the refrigerating switch closed for 4 hours and then turn it on to continue the operation.
5. In case the water supply is cut off, please close the feed water ball valve and cut off the power, after water re-supply, please open the other faucets to discharge sediment and then turn on the feed water ball valve.
6. The machine must use an earthed three-pin socket and a reliable creepage protection switch.
7. Never use organic solvents such as gasoline to clean the machine: strictly prohibit washing the machine with water or splashing water to the machine.
8. Never turn on (off) the machine by inserting the plug into (pulling the plug out from) the socket. Never increase the length of the supply cord to avoid fire.
9. If the supply cord is damaged, it must be replaced by the manufacturer or qualified person so as to avoid a hazard.
10. The water source for the water purifier is civil tap water.
11. Never dismantle spare parts of the machine to avoid water leakage or damage.
12. Never turn the machine upside down or lean it more than 45° when moving it so as to avoid any damage to it or any accident.
13. Limited warranty: electrical components and water system are warranted for 12 months from date of purchasing.

### 3-5.Troubleshooting

In case of failure, please carry out inspection according to the requirements below. If unresolved, please contact the local service agency.

Problem	Reason	Solution
Amount of produced water is reduced seriously	Filter is blocked or not replaced in time	Please contact the local service office to replace the filter in time.
	Water inlet ball valve is not fully opened	Fully open the water inlet ball valve
	Water pressure is too low	Take measures for pressure boosting
Output water quality is low	Filter failure	Please contact the local service office to replace the filter in time.
	Long-term shutdown (over 3 days)	Continuously start and stop the product for 5 times at 40 seconds intervals to automatically flush the filtration system, and feed and discharge the water from the water storage system according to the first step of the Clean Maintenance; after that, the output water can be used normally
	Source water quality is low	Use municipal tap water
No water output after replacing the filter	Water pipe is blocked by air	Please contact the local service office
Screen displays E0	Water leakage	Please contact the local service office
Screen displays Ec, Ed	Water level switch failure	Please contact the local service office
Screen displays Fc, E7	Heating function is abnormal	Please contact the local service office
	Temperature sensor is abnormal	Please contact the local service office
Screen displays E6	Water inlet ball valve is not fully opened	Fully open the water inlet ball valve
	Water pressure is too low	Take measures for pressure boosting
	Filter is blocked or not replaced in time	Please contact the local service office to replace the filter in time.

It is a normal state that the following circumstances occur when the water purifier is used.

1. During the heating, the heating tube may generate slight noises. This is a normal state.
2. When the heating tank is being heated without water, the anti dry-burning device will disconnect automatically and can not reset by its own. The reset must be completed by a professional technician. The design is in accordance with the national safety requirements.
3. When an ambient temperature is higher, the cooling capacity may be slower, which is a normal state.

