



## INSTRUCTION MANUAL

### Wet & Dry Vacuum Cleaner

PLEASE READ THE  
MANUAL CAREFULLY  
BEFORE USING AND  
KEEP IT PROPERLY  
FOR FUTURE USE

Warning notices: Before using this product, please read this manual carefully and keep it for future reference.

The design and specifications are subject to change without prior notice for product improvement. Consult with your dealer or manufacturer for details.

Importer:  
JH Electrical and Appliance Ltd  
3C Short St, Newmarket, Auckland,  
New Zealand

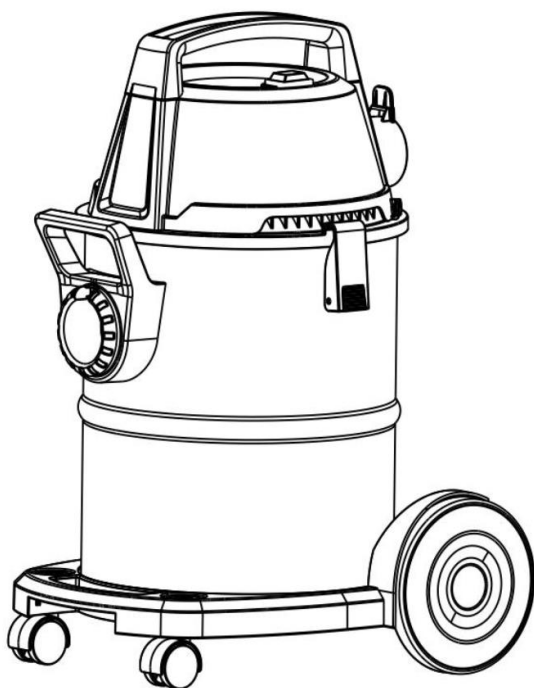

**D4**  
**MDC1516BR**



## IMPORTANT SAFETY INSTRUCTIONS FOR THE USER

Thank you for purchasing and using our wet and dry vacuum cleaner, before using the vacuum cleaner, please read this manual carefully. The safety precautions enclosed herein reduce the risk of fire, electric shock and injury when correctly adhered to.

Keep the manual in a safe place for future reference, along with the completed warranty card, purchase receipt and carton. If applicable, pass these instructions on to the next owner of the appliance.

Always follow basic safety precautions and accident prevention measures when using an electrical appliance, including the following:

### Electrical safety and cord handling

- Before turning on, ensure that your electrical voltage and circuit frequency correspond to those indicated on the appliance.
- To reduce the risk of electrocution, never operate this product or handle the plug with wet hands, submerge it under water or spill liquids into the product.
- Do not insert any objects into the appliance.
- If the supply cord is damaged, it must be replaced by the manufacturer or its service agent or an appropriately qualified person in order to avoid a hazard.
- Check the appliance and cord regularly for visible damage. Do not use it if the cord or housing is damaged, if it has been dropped, damaged, left outdoors or dropped into water, or if any faulty appears. Call the after sales support line if any part appears damaged.
- Do not kink, bend, squash, strain or damage the power cord.
- Do not pull or carry the vacuum cleaner by the cord. Do not use the cord as a handle, close a door on the cord or pull the cord around sharp edges or corners.
- Do not run the vacuum cleaner over the cord. Keep the cord away from heated surfaces.
- Turn off the vacuum cleaner controls before connecting or disconnecting it from the mains supply.



### WARNING

- Always switch off and unplug the vacuum cleaner before connecting or disconnecting the vacuum hose and accessories and before emptying or cleaning the dust tank.
- Do not pull on the cord to disconnect the plug from the power supply. To unplug, grasp the plug, not the cord, and gently pull it out of the power point and then press the cord retraction button to retract the cord.

### Usage conditions and restrictions

- This appliance is intended for household use only. It is neither suitable for commercial/industrial nor for outdoor use.
- Only use the vacuum cleaner on indoor surfaces, as described in this manual and with the original accessories supplied by the manufacturer/distributor.
- Do not use it for any purpose other than described in this manual.
- Improper installation and use may result in the risk of fire, electric shock and/ or injury to persons. We assume no liability for any eventual damages caused by improper or faulty use.
- This appliance is not intended for use by persons (including children) with reduced physical, sensory or mental capabilities, or lack of experience and knowledge, unless they have been given supervision or instructions concerning use of the appliance by a person responsible for their safety.
- Supervise young children to ensure they do not play with the appliance. Close supervision is necessary when any appliance is used by or near children.
- Never leave the appliance unattended.

### Safe usage

- Keep hair, loose clothing, fingers and all parts of the body away from openings and moving parts.
- Keep the end of the hose, wands and other openings away from your face and body.

- Do not point the vacuum cleaner at people or animals when in use.
- Do not use the product without the filters in place.
- Take extra care when vacuuming on stairs.
- Do not use the vacuum cleaner to pick up: hazardous dust, hot materials(burning cigarettes hot ashes, etc.), flammable, explosive, aggressive, liquids(e.g. petrol, solvents, acids, alkalis, etc.), flammable, explosive dust (e.g. Magnesium or aluminum dust etc.)
- Keep the vacuum cleaner away from heat sources (radiator, oven etc.), direct sunlight, moisture and sharp edges.
- Keep all openings free of dust, lint, hair or anything that may reduce the airflow.
- Do not use the product with any openings blocked or restricted airflow.
- Put the vacuum cleaner away after every use to prevent anyone tripping over it.
- Store the vacuum cleaner indoors in a cool, dry area, out of reach of young children.
- Never attempt to open the motor base of the vacuum cleaner yourself or to replace the power cord.



### **WARNING**

- Never use this machine when the suction power becomes very weak.  
When this happens:  
Switch off the unit, unplug it and check whether the dust container is full.  
Then check if any part of the floor brush, tube or hose is blocked.
- Do not use the vacuum cleaner until the blockage is removed and it operates normally again.
- If you cannot solve the problem, contact the after sales support line.
- Always switch the vacuum cleaner off after use, and before plugging it in again, make sure to hold the vacuum cleaner firmly when using it.
- Always switch off and unplug the vacuum cleaner from the electrical outlet before assembling, opening or emptying the dust bag, or before connecting/ disconnecting the attachments.
- If the vacuum cleaner is damaged, it must be repaired by the manufacturer or its service agent or a qualified person in order to avoid a hazard. In case of damage, call the after sales support line for advice.
- Do not point the vacuum cleaner at people or animals when in use.
- Do not use the product without the filters in place.
- Take extra care when vacuuming on stairs.
- Do not use the vacuum cleaner to pick up: hazardous dust, hot materials(burning cigarettes hot ashes, etc.), flammable, explosive, aggressive, liquids(e.g. petrol, solvents, acids, alkalis, etc.), flammable, explosive dust (e.g. Magnesium or aluminum dust etc.)
- Keep the vacuum cleaner away from heat sources (radiator, oven etc.), direct sunlight, moisture and sharp edges.
- Keep all openings free of dust, lint, hair or anything that may reduce the airflow.
- Do not use the product with any openings blocked or restricted airflow.
- Put the vacuum cleaner away after every use to prevent anyone tripping over it.
- Store the vacuum cleaner indoors in a cool, dry area, out of reach of young children.
- Never attempt to open the motor base of the vacuum cleaner yourself or to replace the power cord.
- This appliance can be used by children aged from 8 years and above and persons with reduced physical, sensory or mental capabilities or lack of experience and knowledge if they have been given supervision or instruction concerning use of the appliance in a safe way and understand the hazards involved. Children shall not play with the appliance. Cleaning and user maintenance shall not be made by children without supervision.

# Specification

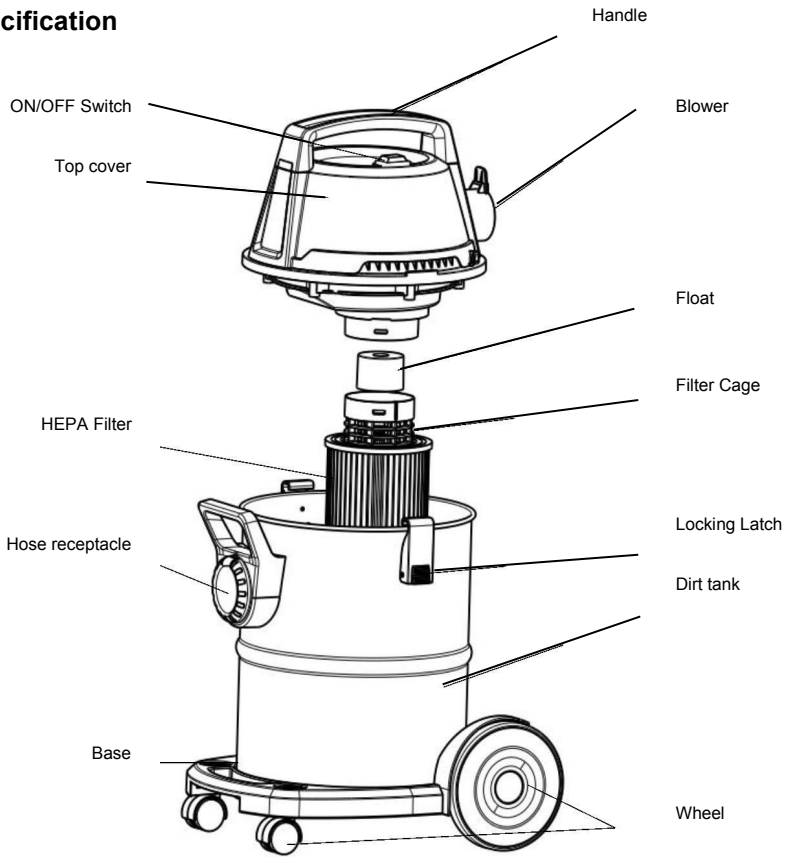

## Accessories List:

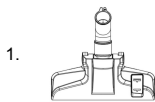

Floor Brush

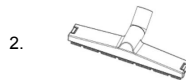

Water Brush

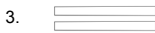

Plastic tube



Hose









Round Brush

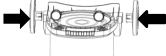

Car Nozzle

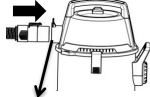

Dust Bag

<b>ASSEMBLY:</b>	
	<p><b>Wheels:</b> Insert the big wheel and the small wheel into the hole of the base.</p>
	<p><b>Hose:</b> Insert the hose connection wand into the hose inlet.</p>
	<p><b>Plastic tube:</b> To use the plastic tube, insert the tube into the end of the hose</p>
	<p><b>Floor Brush:</b> Choose the brush pedal to floor or carpet ,then insert to the suction hole of the plastic tube</p>
	<p><b>2 in 1 water brush</b> When wet use, please assemble the bottom plate; When dry use, please dissemble the plate and use the bristle to clean directly.</p>
<b>BLOWER FUNCTION:</b>	
 <p>Blower outlet</p>	<p>Insert the hose connector to the blower outlet, then you can use the blower function, blower the dust or leaves.</p>
<b>POWER CORD STORAGE:</b>	
 <p>Cord storage hook</p>	<p>Wind the power cord and place it on the cord storage hook.</p>

## OPERATION:



**Always work with HEPA filter during wet as well as dry vacuum cleaning!**

### Dry vacuum cleaning



Work only with a dry HEPA filter and filter bag.

If the suction power is weak, should change the filter bag

If vacuum ashes and soot, should use a pre-separator

### Wet vacuum cleaning



**Caution: Do not use the filter bag!**

Before liquids are picked up, always remove the filter bag, check the float work properly. If foam develops or liquid emerges from the machine, stop work immediately and empty the dirt tank.

## EMPTY THE DIRT TANK:

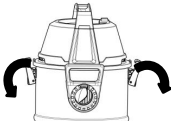

Pull outward to release the locking latch on both side of the dirt tank (Note: Be sure to cut off the power plug beforehand!)

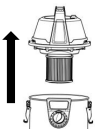

Take off the top cover, remove the filter bag, HEPA filter and pat the dust off them.

## MAINTANCE AND CARE



### **Dangerous**

Turn off the appliance and remove the mains plug prior to any care and maintenance work. Repair works may only be performed by the authorized customer service.



### **Caution**

Do not use abrasives, glass or universal cleaners! Never immerse the appliance in water, especially the motor

Dry filters completely in the air.

- Clean the appliance and accessory parts made of plastic with clean water and squeeze the water out,
- don't clean them with washing machine,
- If required, rinse the container and accessories with water properly and dry them before reuse,
- Only clean the HEPA filter under running water; do not wipe or brush. Let it dry completely before installation.

## **TROUBLE SHOOTING**

If the cleaning power of the appliance deteriorates please check the following

- Accessories, suction hose or suction tubes are clogged, please remove the obstruction,
- Filter bag is full, install new filter bag,
- HEPA filter is blocked, clean under running water if necessary,
- Replace damaged HEPA filter.