

USER MANUAL

WATER PURIFIER

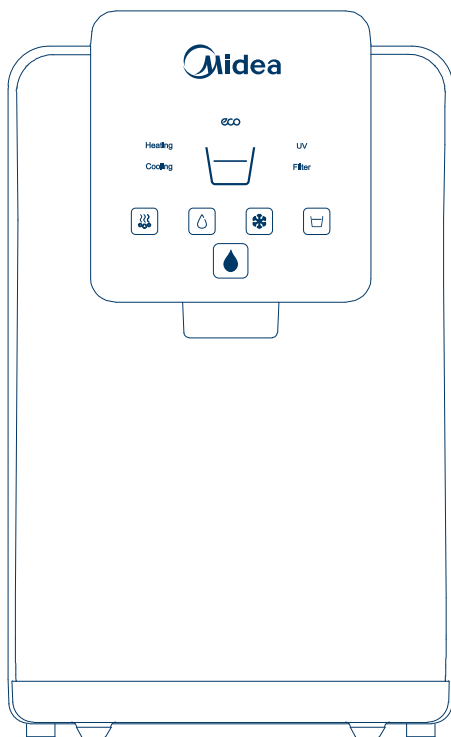

Please read the Manual carefully before use.
The Manual shall be kept in good custody for later reference

MODEL: JL1645T

www.midea.com

1. Precaution

1-1. Safety Issues

Please note the following brief icons and rules for safe use of this product



Troubleshooting

When the machine fails, please disconnect the power and water source immediately



Maintenance

Never remove the parts on the machine to avoid leakage or damage



Avoid contact with children

Never have the machine operated by a child

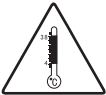

Temperature

Please use the product in a dry place with the temperature of 4–38°C



Electricity prevention

To avoid leakage of electricity.



Accessories and filters

To maintain the normal operation of the machine, be sure to use accessories and filters supplied by original company



Emergency call

For any help, please call the local sale service center or the national service hotline



Correct repair service

This machine can only be repaired by qualified personnel designated by this company



Avoid direct sunshine

Do not install the machine in a place exposed to direct sunshine



Anti-freeze

Never store or expose the product in an environment less than 0°C

- This appliance is not intended for use by persons (including children) with reduced physical, sensory or mental capabilities, or lack of experience and knowledge, unless they have been given supervision or instruction concerning use of the appliance by a person responsible for their safety.
- Children should be supervised to ensure that they do not play with the appliance.
- If the power cord is damaged, it must be replaced by the manufacturer, its service agent or similarly qualified persons in order to avoid a hazard.
- Do not store explosive substances such as aerosol cans with a flammable propellant in this appliance.
- This appliance is intended to be used in household and similar applications such as staff kitchen areas in shops, offices and other working environments; farm houses and by clients in hotels, motels and other residential type environments; bed and breakfast type environments; catering and similar non-retail applications.
- **WARNING:** To avoid a hazard due to instability of the appliance, it must be fixed in accordance with the instructions.
- The appliance must not be immersed.
- This machine is applicable to the water environment with TDS value less than 250 in case of the high water hardness lead to incrustation even breakdown of the hot tank.

1. Precaution

- **WARNING:** To avoid a hazard due to instability of the appliance, it must be fixed in accordance with the instructions.
- The appliance must not be immersed
- The appliance must not be cleaned by a water jet.
- **WARNING:** Do not operate the UV Electric ballast when it is removed from the appliance enclosure.
- This appliance contains a UV Electric ballast.
- Unintended use of the appliance or damage to the housing may result in the escape of dangerous UV-C radiation. UV-C radiation may, even in little doses, cause harm to the eyes and skin.
- Appliances that are obviously damaged must not be operated. the replacement of the UV Electric ballast by the user is not allowed, the appliance is to be supplied through a residual current device (RCD) having a rated residual operating current not exceeding 30 mA.
38°C ±1°C on appliances of subtropical (ST) class.
43°C ±1°C on appliances of tropical (T) class.

1-2. Packing List

Packing box	Water Purifier (1 set) 1/4"PE pipe (3m)
Materials bag	User's Manual (1copy)
Materials bag	6/8 " -2/8 " connector " (1pc)

2. Your Direct Drinking Water Purifier

2-1. Part Name of Water Purifier

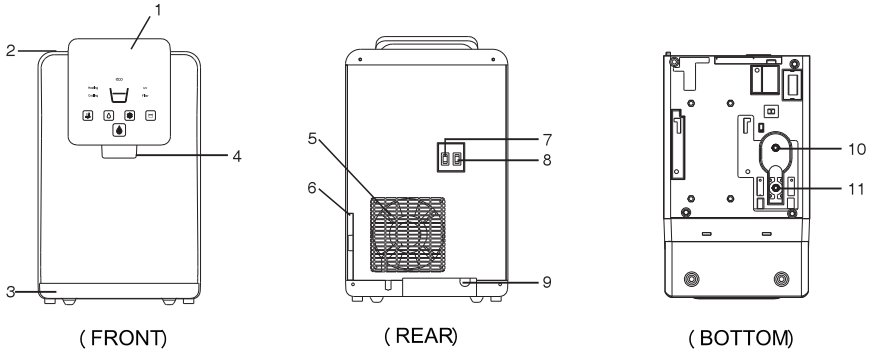

No.	PART NAME	No.	PART NAME
1	Display screen	7	Cooling switch
2	Top cover	8	Heating switch
3	Drip tray	9	Water inlet
4	Water outlet	10	Cold water drainpipe lid
5	Fan	11	Hot water drainpipe lid
6	Dust gauze		

Note: Please use the product in a place with temperature of 4-38°C and relative humidity less than 90%.

*** To enhance product performance, product parts may be changed without notice. The object shall prevail.**

2. Your Direct Drinking Water Purifier

2-2. Model and Major Parameters

Model	780165
Rated Power	555W
heating Power	420W
Cooling Current	1.0A
Rated pure water flow	1.2L/min(0.3MPa)
Hot water capacity	4 L/h($\geq 85^{\circ}\text{C}$)
Cold water capacity	3 L/h($\leq 10^{\circ}\text{C}$)
Applicable environment	4-38 $^{\circ}\text{C}$ humidity $\leq 90\%$
Applicable water pressure	0.18-0.4MPa
Applicable water	Tap water
	TDS $\leq 350\text{ppm}$
Stage 1	Carbon block & UF membrane Filter
Product size	260(W)x435(D)x425(H)mm
Packing size	322(W)x514(D)x510(H)mm
Net weight	13.5 kg
Gross weight	14.8 kg

2-3. Product Features

1. 3 Temperature Selection.
2. Replace filter indicator.
3. Fixed water volume function. Hands free dispensing.
4. Carbon block & UF membrane Filter reduces odor, chlorine, smell, organism, bacteria.
5. Sediment filter eliminates rust and dirt particles.
6. High-efficiency and low noise compressor for cooling.

2. Your Direct Drinking Water Purifier

2-5. Working Principle

1. Flowchart of water generation

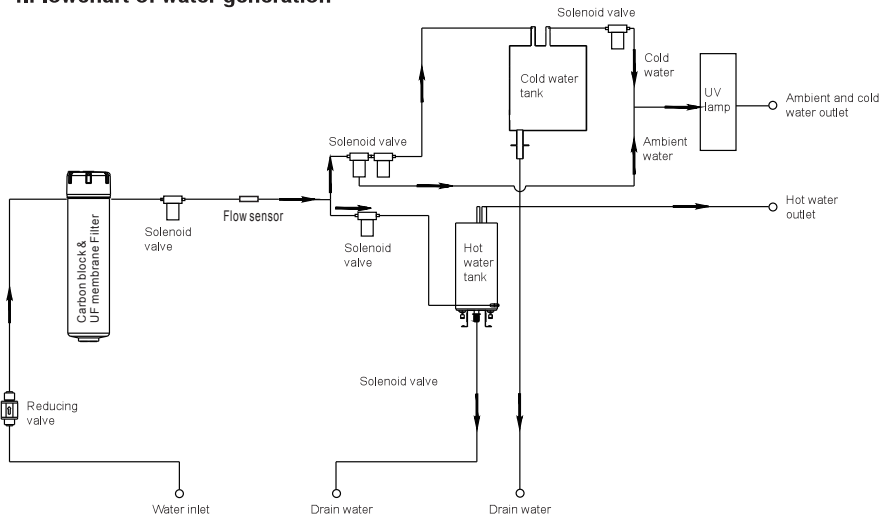

2. Circuit diagram

CIRCUIT DIAGRAM

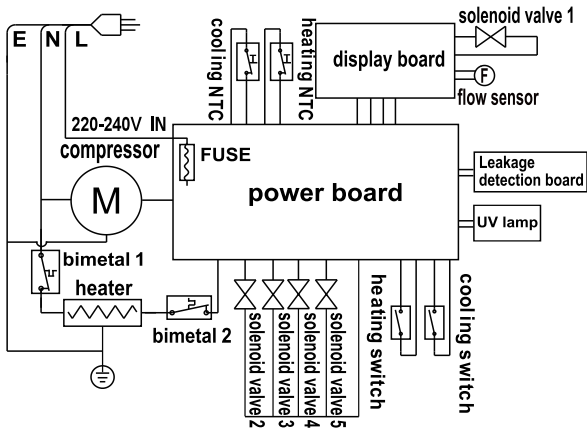

2. Your Direct Drinking Water Purifier

● Filter Function Introduction

Stage	Filter	Function
Stage 1	Carbon block & UF membrane Filter	Absorb unusual colors and odors, Remove residual chlorine and organic substances in water. Remove bacteria, iron rust, colloids and impurities in water.

3. Use Guide and Maintenance



Please cut off water source before replacing filters. Never plug filters in water running state.

3-1. Guidance on Unpacking and Installation

1. Open the top of the packing case, take out the top foam and its accessories.
2. Put the accessories aside.
3. Unpack the product, install the water collector.
4. Before installation, To study the use of the quick connector.

Connect the tubing

The system includes push-in fittings for quick tubing connection. Review the following instructions before connecting the tubes in the next step.

Cut tube to length:

- 1). Use a sharp cutter or knife to cut the end of tubing. Tube should be cut flat.
- 2). Inspect the end (about 30 mm) of the tubing to be sure there are no nicks, scratches or other rough spots. If needed, cut the pe tube again.

Connect tubes:

- 1). Push tube through collet until it engages the o-ring. Continue pushing the tube into the O-ring to the end of the fitting. A common mistake is that the tube is not pushed to the end. This will lead to future leaks. When a 3/8" tubing is fully engaged, 20 mm of the tube has entered the fitting (Figure 4).
- 2). We recommend you to use the tube from the manufacturer, its agency or equal qualified personel, be sure it is of high quality, exact size and roundness with a smooth surface.

Tube partially engaged with fitting

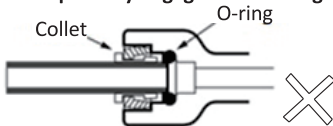

Tube fully engaged with fitting

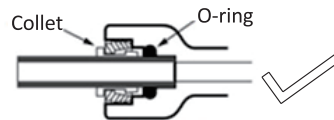
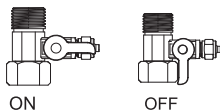

Figure 4

Disconnect tube:

- 1). Push the collet inward with finger tips and hold it.
 - 2). Pull the tube out.
5. Take out the quick joint, and install it on the water pipe.



(1)

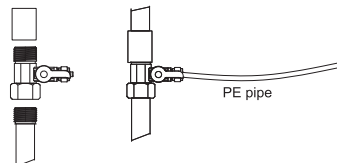

(2)

3. Use Guide and Maintenance

6. Filter should be cleaned for the first use. Remove the top cover, take out the filter and then connect to PE tube (Follow the indication on the filter head and insert the inlet and outlet) . Turn on the faucet to flush the filter for 10 minutes, and then install it back to the machine.

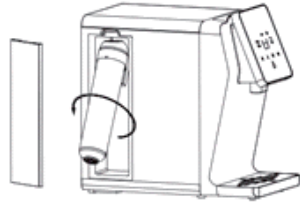
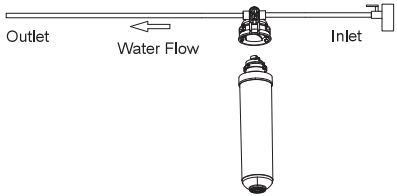

7. When installing the machine, please pay attention to the installation dimension in case of the blocking of air inlet and outlet.

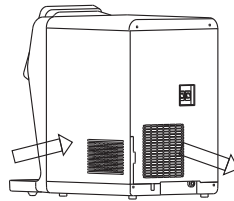
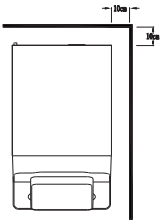

8. Drip tray cover must be properly placed inside the machine. No suspending in midair in case of falling off.

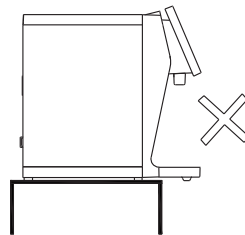
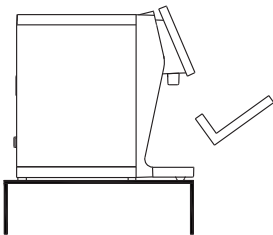

3. Use Guide and Maintenance

9. Take out the pin of the quick joint at the rear of the product's base plate, and then take out the blue plug.

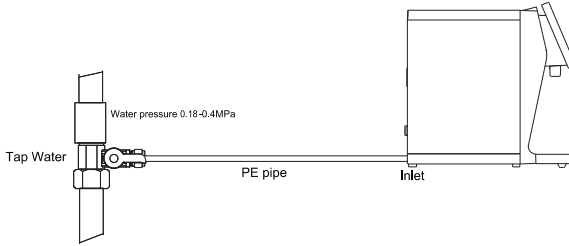

10. Insert the water inlet PE pipe in the quick joint, and tighten the pin.
11. The power cord of water dispenser should be plugged into the switch socket with safety grounding
12. When installing filter and replace filter please turn off the water and power supply before installation and replacement.
13. After installation, plug on the machine, and it can be used normally.

3-2. Using The Product

Start up

1. Power on, start to use the product.
2. When using it for the first time, press the cold water output and hot water output buttons till discharging cold water and hot water from the faucet, ensure to remove the air from the hot tank and cold tank, to prevent dry heating and dry cooling.
3. After step 2, then turn on the heating and cooling switches on the rear side according to the actual requirement, start the heating and cooling functions, the green one is the cooling switch and the red one is the heating switch.

3. Use Guide and Maintenance

Control Panel



Icon	Description	Icon	Description
	Hot Water Button. Touch the Hot Water Button, this icon lights up, It means you Select the hot water.	Heating	Heating Indicator When heating, the heating icon is on, after heating or when the product is not heating, it is off.
	Ambient Water Button. Touch the Ambient Water Button, this icon lights up, It means you Select the ambient water .	Cooling	Cooling Indicator When cooling, the cooling icon is on, after cooling or when the product is not cooling, it is off.
	Cold Water Button. Touch the Cold Water Button.,this icon lights up, It means you Select the cold water.	UV	UV Working Indicator When the UV sterilizing is enabled, UV icon turns on.
	Quantitative Water Output Button. Touch the Quantitative Water Output Button, this icon lights up, It means you Select the quantitative water output function.	Filter	Filter Life Indicator When the filter life is not expired, the indicator is on; after the filter life expires, the indicator flashes.
	Taking Water Button Press this button to get water.		After power on, the Cup icon keeps on.
	ECO Button. Touch to turn on / off Eco Mode in which the heating and cooling function is disabled and energy is being saved.		

Operation Requirements Instructions

1 taking water function

1.1 Water output after selecting water temperature

Press the water temperature button, corresponding indicator turns on, within 5s, press the “Taking Water button” to output water , during the water output process, press the “Taking Water” button again, the indicator turns off, and the product stops outputting water. After stopping water, the water temperature selection automatically switches to “Ambient Water” 5s later. During the water output process, the Water Temperature Selection button and the Quantitative Water Output button are not workable.

3. Use Guide and Maintenance

1.2 Quantitative water output after selecting water temperature

Select the Water Temperature button, corresponding indicator turns on, then select the Quantitative Water Output button, Quantitative Water Output indicator turns on, within 5s, press the "Taking Water" button to output water, after outputting water for 10S, the water output is automatically stopped, the Quantitative Water Output indicator turns off. During the water outputting process, press the "Taking Water" button again to stop outputting water, the Quantitative Water Output indicator turns off. After stopping water, the water temperature selection automatically switches to "Ambient Water" 5s later. During the water output process, the Water Temperature Selection button and the Quantitative Water Output button are unavailable.

2 ECO Function

Under the state that ECO function is enabled, if it detects that the light diminished, it will turn off the heating and cooling function. If it detects that the light turned bright, the heating and cooling function will be recovered automatically.

3-3. Filter Replacement Cycle

Carbon block & UF membrane Filter
6-12 month

Special hints:

The data above are for references only. It is based on 10 L per daily drinking water. The specific cycle for replacement of filters varies with local water quality and water amount consumed.

while the "Filter" is twinkling, it indicates the filter should be changed as the schedule. After you replace new cartridges, please long press "ECO" button until "Filter" stops twinkling to reset the filter indicator.

3-4. Maintenance

1. Keep this machine in a dry and cool place and avoid direct sunshine.
Never put the machine on paper or foam, which may store water and then cause electricity leakage.
Never put anything flammable beside this machine. Do not use the machine outdoors or in a Place that can be splashed by water.
2. For the water purifier, the installation and replacement of filters must be carried out by qualified personnel.
3. In case the machine is not in use for a long time, turn off the heating switch or the cooling switch to save power.
4. In case the machine is not needed for a long time, please turn off the Cooling switch and the Heating switch and taking out hot water form water outlet. Then please take off the plug, turn off the water inlet .After that, please Pull the plug and then drain off the remaining water.

3. Use Guide and Maintenance

5. In case the water supply is cut off, please close the inlet water ball valve and cut off the power. After water re-supply, please open the other faucets to discharge the sediments remained in the water net and then turn on the inlet water ball valve.
6. The machine must use an earthed three-pin socket and a reliable creepage protection switch.
7. Never use organic solvents such as gasoline to clean the machine; strictly prohibit washing the machine with water or splashing water to the machine.
8. Never turn on (off) the machine by inserting the plug into (pulling the plug out from) the socket. Never increase the length of the supply cord to avoid fire.
9. If the supply cord is damaged, it must be replaced by the manufacturer or qualified person so as to avoid a hazard.
10. The water source for the water purifier is civil tap water.
11. Never dismantle spare parts of the machine to avoid water leakage or damage.
12. Never turn the machine upside down or lean it more than 45° when moving it so as to avoid any damage to it or any accident.
13. NOTE: To clean the thimerosal in the machine, take cold / hot /ambient 2.0L each 3 times before use this machine first time.



14. NOTE: Inactivation Cycle

- Never drink the first cup of water overnight or after a pause of more than 10 hours, drink any kind of water after discharging the first cup of water. For the inactivation cycle of the water dispenser, although the water dispenser is running, it does not supply water
- If the connection between water dispenser and water network keeps inactive for 48 hours, at least 2L of cold water should be discharging before drinking.
- If the water dispenser keeps inactive for 15-20 days, safe disinfection shall be carried out at least before drinking.
- If the water dispenser keeps inactive for more than 20-25 days, it is necessary to re-sterilize and replace the filter at least before drinking.

3. Use Guide and Maintenance

3-5. Troubleshooting

In case of failure, please carry out inspection according to the requirements below. If unresolved, please contact the local service agency.

Failure	Cause	Solution
Small water flow/No hot water, Heating and  lights flashing	Low water pressure	Check the tap water, If water pressure is very low, please wait for the pressure return to normal and then take cold or ambient water to restart heating function.
	Filter is blocked	Please replace the filter and then take cold or ambient water to restart heating function.
Abnormal Water temperature	Over consumption of water in a short time	Just wait a moment, and water is available again
	Power supply not put through	Switch on power supply
	Corresponding functions not started	Press a corresponding function key to start the function
Water leakage	Pipe not connected properly	Inspect the connector to connect the pipe properly
	Water pipe and PE pipe bursting	Replace the water pipe and PE pipe
"  " light flashing	there should be leakage.	check the PCB on the base plate. Repair the machine and dry the PCB, and then power on again.
Electric leakage	The earth connection is not well connected	Use a three-pin socket with earth wire, making the machine grounded properly
Noisy operation	Not installed steadily	Place the machine on a steady & solid surface
Machine fails to run	Power supply not put through	Switch on power supply

It is a normal state that the following circumstances occur when the water purifier is used.

1. During the heating, the heating tube may generate slight noises. This is a normal state.
2. When the heating tank is being heated without water, the anti dry-burning device will disconnect automatically and can not reset by its own. The reset must be completed by a professional technician. The design is in accordance with the national safety requirements.
3. When an ambient temperature is higher, the cooling capacity may be slower, which is a normal state.



make yourself at home