

Smart toilet seat Manual

The Product Model:

- ◆ Thanks for choosing our product.
- ◆ And please read the instructions carefully before using.

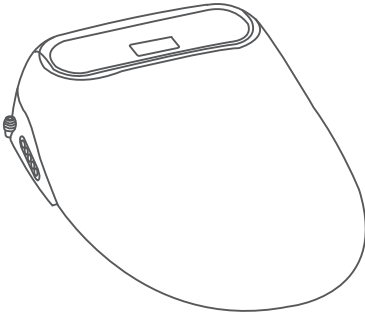

General

General

Overall sketch	1
Safety precautions	2
Function introduction	4
Installation guide	5

Use

Control panel introduction	9
Preparation	9
Product use	10
Cleaning and maintenance	16

Appendix

Product specification	19
Packing list	20

Overall sketch

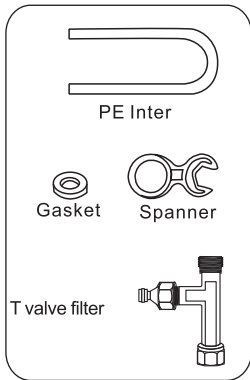
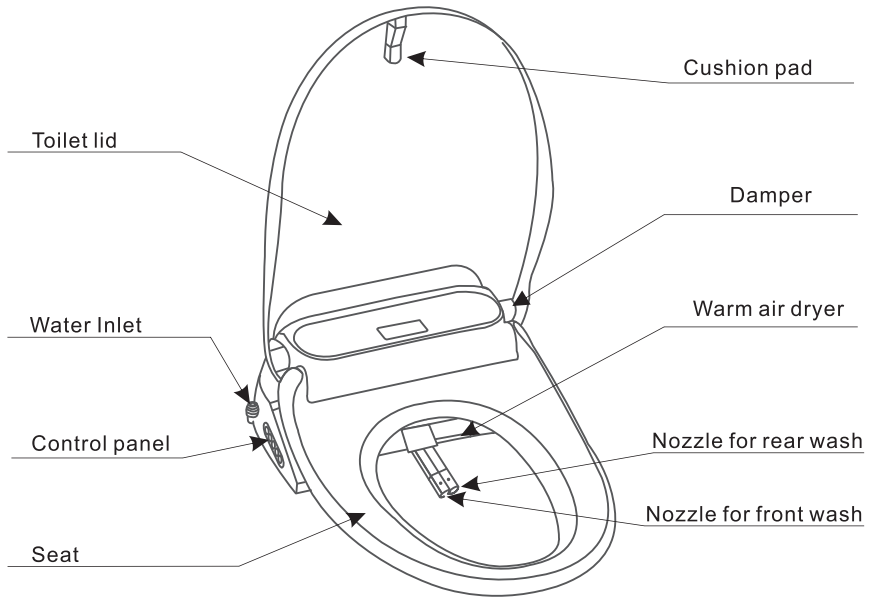

Water pipeline connecting accessories

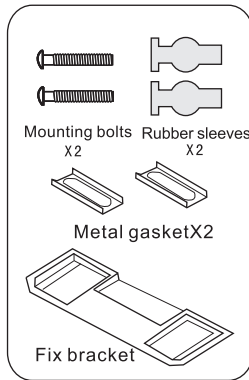

Fix machine parts

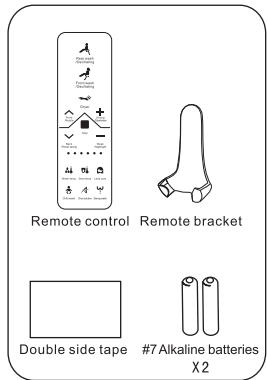

Remote control

Attention:

The specification, design and color of the instruction may differ from the end-product purchased. In the case, please refer to the end-product about the assemblies.

Safety Precautions

All the safety precautions listed can prevent the users from physical injuries or property losses. Please read all the safety items and warnings, using the product correctly.



WARNING

Ignoring the sign may lead to serious injury or death.



Don't disassemble, repair, alter the product.

- ◆ All the behaviors above may lead to fire or electric shock.
- ◆ The product needs to be repaired professionals.



Don't immerse the product into the water. If the operating environment has a quite high humidity, please install scavenging port and seal the attaching plug with rubber.



Don't touch the plug with the wet hand.

- ◆ It may lead to electric shock.

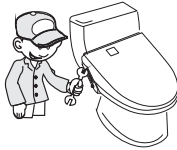

Connect the grounding wire with the product to prevent electric discharge or electric shock.

- ◆ If the grounding wire is not connected with the product, it may lead to electric discharge or shock.
- ◆ The grounding wire needs to be connected with the product by a professional.

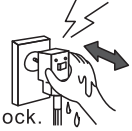

Don't power on before pouring water.

- ◆ It may cause fire.



Don't use the loosening plug. The electric wire should not be scratched, damaged, processing, bending, stretching bundling, hang heavy things or clamped

- ◆ It may cause electric shock or fire.





WARNING

Ignoring the sign may lead to serious injury or death.



Don't stand on the toilet seat cover, or any other accessories.

- ◆ It may cause the product to break



Don't open down and close down the toilet seat or toilet cover roughly.

- ◆ It may crack the toilet seat or toilet cover and lead to electric discharge.



Don't drag or bend the water pipe.

- ◆ It may make water leakage or no water supply.

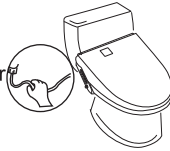

Don't install or leave the remote control near the water.

- ◆ It may cause the remote control to malfunction



Prevent damage from freeze.

- ◆ The inlet tube and the inner of the product may be damaged for freezing, and then lead to water leakage.



Attention to the low temperature scalding.

- ◆ After using a long period, please turn off the heat preservation button near the seat circle.
- ◆ Please turn off the button for these groups: children, elders, patients, people unable to adjust the temperature, people with weak skin, people taking sleeping pills, alcoholics, the tired.



Don't put heat instruments beside the product.

- ◆ It may change the color of the substance or even break down the substance. Please avoid the direct sunshine.
- ◆ Sometimes it may change the color of the plastics. Don't cover the warm air outlet.
- ◆ It may cause fire injury.



The product cover, seat circle and seat cover are all plastics products. Don't bring fire source like cigarette butt, ashtray near these assemblies.

- ◆ It may lead to fire.

Declaration: In the event that accident occurs as a result of improper usage, company will assume no responsibility.

Function introduction:

Functions	Introduction
Rear wash	Wash posterior
Rear oscillating wash	Rear wash with nozzle swinging
Front wash	Gentle wash for women only
Front oscillating wash	Gentle front wash with nozzle swinging
Temperature control	Adjust seat and water temperature
Water pressure adjustable	Adjust water pressure for washing
Seat sensor	Functions activated by sitting on the seat
Heated seat	Make you feel comfortable and warm at cold winter
Warm air dryer	Dry wash position
Drying intensify control	Adjust drying temperature
Power on/off	Control power
Energy saving	Electricity saving system
Nozzle self-cleaning	Nozzle spray out water for cleaning
Mute anti-collision	Built in damper,close seat slowly
Wash position adjustment	Adjust the wash position
Deodorizer switch	Turn on/off deodorizer
Nozzle self cleaning	Clean nozzle itself
Smart remote control	Allow the user to operate the toilet from a comfortable position

Installation Guide

※ Installation environment

- 1、 Before installation, toilet wall, floor tile, ceramic toilet has been completed, bathroom should supply water and power socket near by toilet.
- 2、 Water pressure should be between 0.06Mpa(flow)-0.75MPa (Static),water temperature 4℃-35℃.
- 3、 Forzencase, please put the product in a warm place wait to thaw then install it.
- 4、 Connect daily-use water pipe only.
Do not connect to recycled water or industrial water supplies.
Due to possible contamination as this would cause jamming or internal damage.
- 5、 Please be sure to use incidental T valve and filter.
- 6、 Don't put the power plug into the socket before finishing installation.

※ Install T valve

- 1、 Lock inlet valve to remove water pipe. See Picture 1.
- 2、 Connect T valve, filter and inlet valve. See picture 2.
- 3、 Install flush tank and inlet pipe. See picture 3.

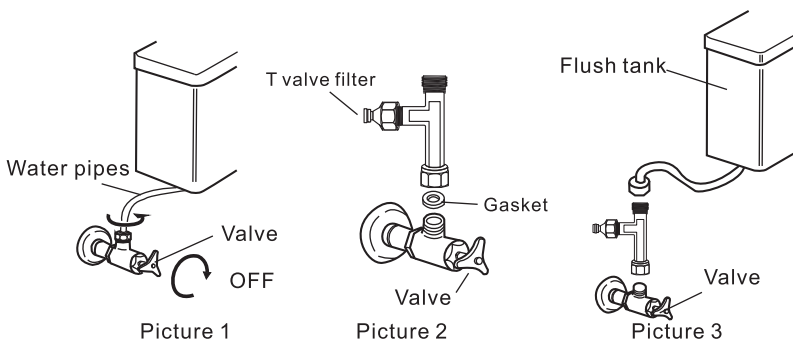

※ Install bidet

① Remove original toilet seat

1. Loss nut.
2. Take out toilet seat.

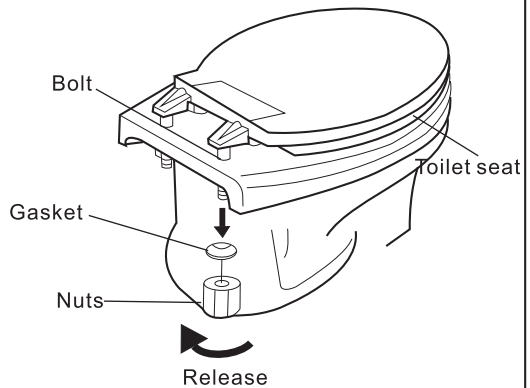

② Install fix bracket

1. put the rubber sleeves into toilet installation hole.
2. put the fix bracket on toilet then start to install it.
3. with the mounting bolts on the bracket fixed the toilet.

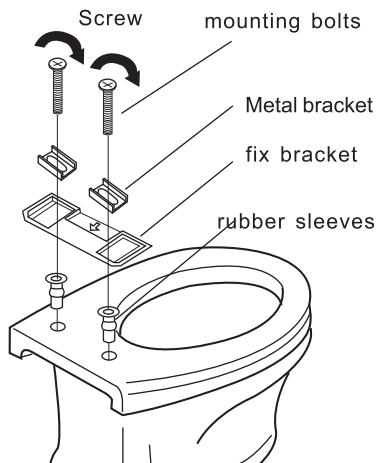

※ The fix bracket can adjust the rang within 130-170mm

※ Install bidet

③ Install bidet

Push the product and slip into fix bracket and lift bidet to send it into fitter place

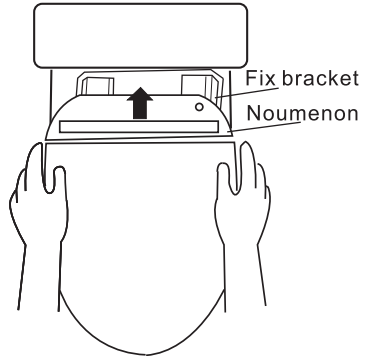

- ※ Notice: please don't forget the power cable between the toilet and bidet.

Be sure the bidet fixed as complete then lift bidet to fit it on correct position.

※ connect inlet pipe

① Connect T valve

1. Take out clip from connector of T valve.
2. Hold on PE Inter to push it towards connector of T valve.
3. Reinstall clip to original position.

② Connect bidet

1. Take out clip from connector at the side of bidet.
2. Hold on PE inter to push it towards connector of bidet.
3. Reinstall clip to original position.

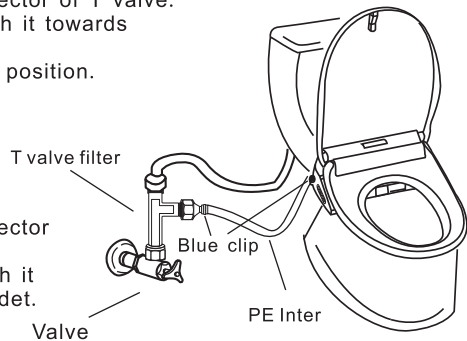

- ※ Turn on inlet valve after connected, please check the connector part leakage or not.

※ Preparation for water supply and Test for operation

1. Insert electric plug into the socket.
2. When the indicator light is on, All indicator lights or LED display are shining, at the same time, water flows into the inner water tank, the process will cost about 11s. Then water sprays out from the nozzle. All indicator lights are off with a sound “Di” for once.
3. Press the power button on toilet or on remote controller, then the power indicator light or power icon in LED display is on, and the toilet is in the condition of work.
4. Adjust temperature of water and toilet seat to appropriate condition
5. Follow the instructions to operate, press buttons as told, and test every action.



◆ Install the Remote Control Holder

■ Please see below picture

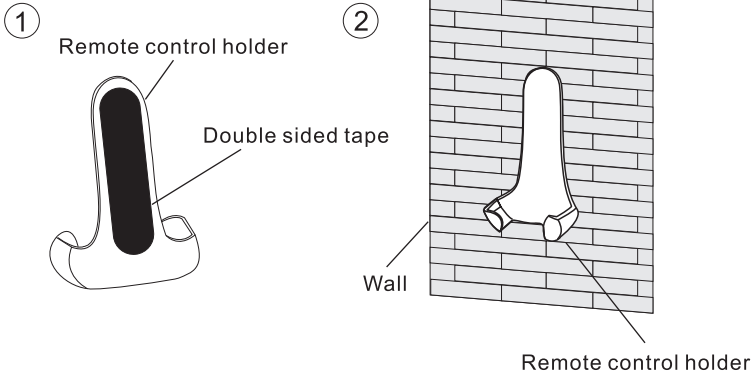

Paste the tape on the backside of remote control, fasten the remote control holder to the wall

Notice: clean the installation position before pasting and press the tape down fully and evenly when positioning. While after pasting, do not touch the holder within 15 minutes

Operations

◆ Operation introduction

This product is controlled mainly by remote control, while by control panel subsidiary. Please note below picture is only for illustration that how LED displays in full screen, not the actual interface.

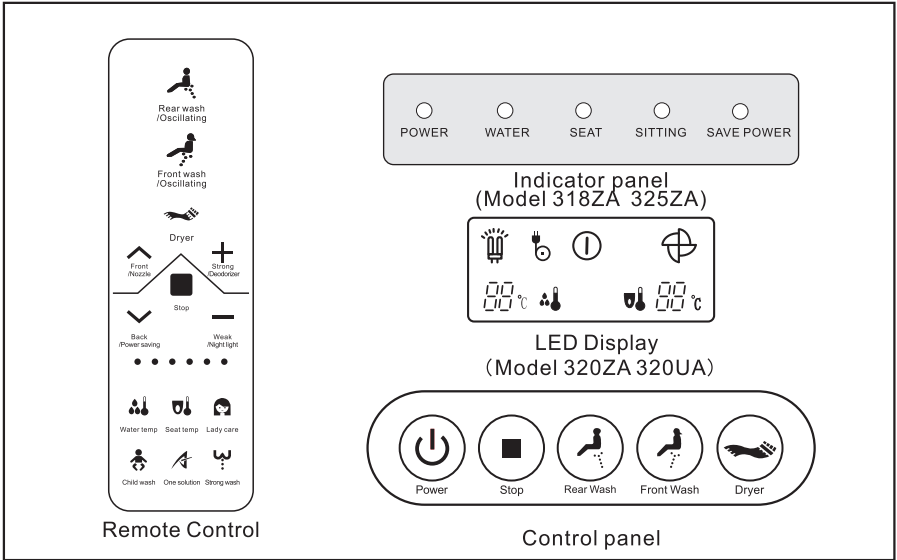

◆ Preparations before Use

1. Ensure the plug is inserted into socket and the indicator light is on.

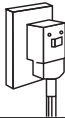

2. Open the water-inlet valve

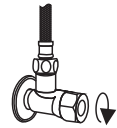

3. Confirm the power icon in LED display is on



4. Press the Power Button on the panel or turn on the power by remote control; also confirm power LED on the toilet is on otherwise it cannot be operated.



◆ Product use manual

Sitting on the toilet seat

Seated-sensor activated

If air purification is activated, deodorizing function operates automatically.



Rear wash/ Oscillating

Press this button, rear wash nozzle reaches out to work; Press again change to rear oscillating cleansing, the indicator #1 blink on remote control, nozzle repeatedly swings back or front. Press again, stop oscillating cleansing. Switch back to rear wash.

Front wash/Oscillating

Press this button, front wash nozzle reaches out to work; Press again enters front oscillating cleansing, the indicator #1 blink on remote control, nozzle repeatedly swings back or front. Press again, stop oscillating cleansing. Switch back to front wash.

Nozzle position adjustment

5-paragraph for adjusting the satisfied position to clean by pressing  Front Nozzle  Back Nozzle (Power saving)

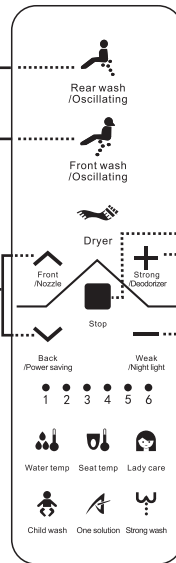

Attention: In oscillating cleansing model, the position of nozzle cannot be adjusted.



Stop

Stop the current cleaning operation. After rear wash/front wash 2 minutes, it will stop automatically if do not press stop button. Press this button for 3 seconds to shut down smart toilet seat.

Water pressure adjustment

4-paragraph for choose, adjust comfortable water pressure by  

Strong Deodorizer Night light

Stop

Stop current drying operation. After dry for 4 minutes, it will stop automatically if do not press stop button. Press this button for 3 seconds to shut down smart toilet seat.

Dryer

Press this button to start warm air drying.

Warm air temp adjustment

4 - paragraph for choose, adjust warm air temp by pressing

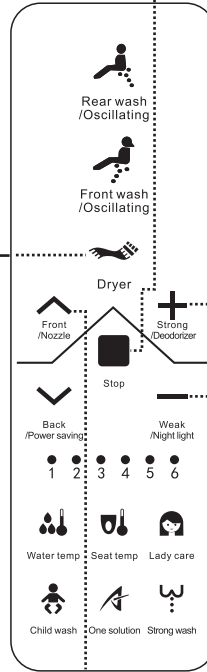

Nozzle self-cleaning

Press  on remote control in standby mode, then water flows out to clean nozzle. Repeatedly press this button, the nozzles switch between rear and front cleansing, then you can clean and replace the nozzles.

- *Self-cleansing Button is available when no one sits on the toilet.
- *It will clean the nozzle automatically before rear cleansing and front cleansing.

Water temp adjustment

Press this button enter water temp adjustment. 4-paragraph for choose, not heating under normal temp level, switch to another shift with each press. Its are orderly: Mid grade—High grade—Mid grade—Low grade—Off—Low grade—Mid grade—High grade, the three indicators of the remote control #1,#2,#3 correspond to the status display. 39°C High grade— 36°C Mid grade—33°C Low grade.

Night light

Press this button to turn on the light, the indicator #4 blink on remote control in standby. Press again to close, it can be switched between on and off.

Tip: Standby mode means that the toilet seat is in an operational state, that is, the toilet seat is not in the state of washing, drying, nozzle self-cleaning, etc.

Seat temp adjustment

Press this button enter seat temp adjustment. 4-paragraph for choose, not heating under normal temp level, switch to another shift with each press. Its are orderly: Mid grade—High grade—Mid grade—Low grade—Off—Low grade—Mid grade—High grade, the three indicators of the remote control #4,#5,#6 correspond to the status display. 39°C High grade— 36°C Mid grade—33°C Low grade.

Attention: To prevent the low temp burn, the 35°C toilet seat will automatically lowered to below after sit on the seat for 10 minutes.

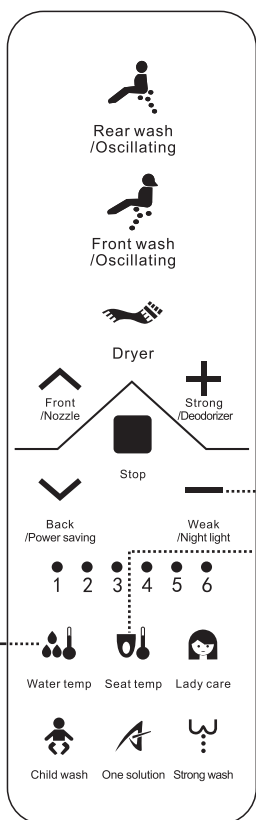

Power saving

Press  to enter automatically power save mode, the indicator #3 blink on remote control in standby. Press again to close, it can be switched between on and off.

Tip: Standby mode means that the toilet seat is in an operational state, that is, the toilet seat is not in the state of washing, drying, nozzle self-cleaning, etc.

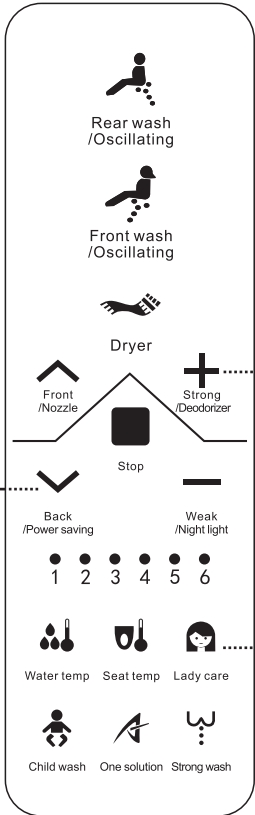



Deodorizer



Power on default start automatic deodorization. Press this button  to close in standby. Press again to start, the indicator #2 blink on remote control, it can be switched between on and off.

Reminder
Deodorizer will turn off when blowing-drying function. Deodorizer will go on working for 1.5 minutes when people leave the toilet seat.

Lady care

Press , front wash nozzle reaches out to work and water temp is set to the highest level (39°C), water pressure is set to 2 paragraph, cleaning position is default. Water temp/water pressure unadjustable, cleaning position adjustment in standby. Press again, it can be switched. Automatic ends after cleaning for 2 minutes. Press  to end Lady care mode.

Child wash

Press  , front wash nozzle reaches out to work and nozzle position is at the front (5 paragraph), mini water pressure(1 paragraph), water temp is mid grade (36°C). after washing 30 seconds to end. Press  to end child wash mode

Attention: Cleaning position/water pressure/water temp and other parameters are unadjustable when start child wash.

One solution

Press  to start, the order is rear wash 40 seconds → oscillate wash 20 seconds → warm air dryer 2 minutes → stop.

In this process, press  to end one solution mode.

Strong wash

Press  , rear wash nozzle reaches out to work and water pressure is highest grade, after washing 2 minutes to end.

Press  to end strong wash.

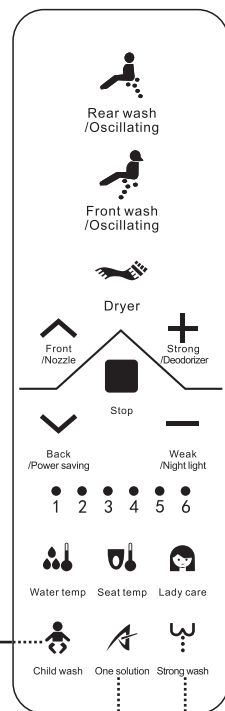

Buzzer

Buzzer
Buzz once: Normal operation-receives instructions from the buttons on the remote control
Buzz twice: Auto operates when users leave
Buzz three times or above: Indicates malfunction or disorders. Buzzering intervals depends.

Indicator light

Indicator light	
power indicator	When the power is on, the indicator light is on. If there is something wrong with flushing components, the indicator light will blinking.
seat temperature indicator	When the toilet seat is heating, the indicator light is on. If it is over heated, the indicator light will blinking.
water temperature Indicator	When the water is heating, the indicator light is on. If it is over heated, the indicator light will blinking.
seat indicator	When seated, the indicator light is on. If water level is low, the indicator light will blinking.
energy saving indicator	When it goes into energy saving mode, the indicator light is on.

LED display (Model only 320ZA 320UA)

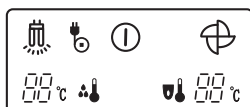

Power	keep lighting, means the power is turn on
Seat temperature	When seat heated, the temp will be showed by figure, when with error,temp figure will show by figure letter, when show F, it means the seat temp over temp. When show E, it means the seat temp sensor with problem
Water temperature	When water heated, the temp will be show by figure, when with error, the temp figure will show by figure letters; When show D, it meansheater will problem; When show E, it means the water temp sensor with problem; When show F, it means current water temp over temp
Seated sensor	After sit on toilet seat, keep shining
Power Saving	When under power saving, will show in LED display
Night light	When press night light, will show in LED display
Deodorant	When you set deodorant and sit on the seat, will show in LED display

Cleaning and Maintenance

● Cleaning the Toilet Seat

- ◆ Do not use corrosive solvents to clean the toilet seat, such as banana oil, benzene, decolorizer, cleaner, and diluter. Also do not use water to rinse the equipment as this may cause short circuits, resulting in a fire.
- ◆ Pull out the plug before cleaning in case that plug or the outlet gets wet by water.
- ◆ Scrub the toilet seat gently by soft cloth. If it is very dirty, get the cloth wet and clean the unit by neutral agents.

● Cleaning and Maintenance the Nozzle

- ◆ Press Nozzle Cleaning Button and water sprays out. Press the button a second time then the rear nozzle extends and press again, feminine nozzle extends too. Clean the nozzles with brush.

◆ Replacing the Nozzle (except stainless steel nozzle)

Hold the front end of the nozzle tip and turn it counterclockwise when nozzle extends. Then pull it out. Replace the tip, insert into the nozzle and turn it clockwise.

**Do not force the nozzle tip out or bend it.

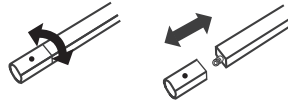

● Cleaning the filter

When the water pressure is too low or insufficient, please clean the filter.

1 Close the shutoff valve and stop water supply.

Notice: Do not remove the filter without closing the shutoff valve. otherwise water will spray out.

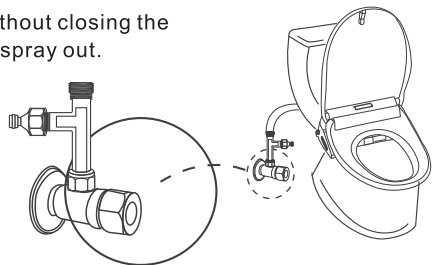

2

Disassemble filter

please use spanner to back-out one touch fitter, take out filter in T valve; turn on the cover of filter to take out filter, please see picture.

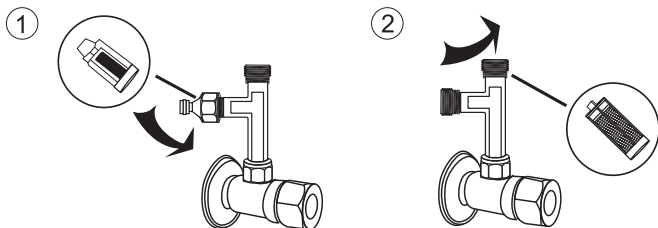

3

Clean

Take out filter to clean the scale via brush.
Please wash it in clear water or brush.
Notice: please don't use detergent to clean it.
Please softly wash the filter net to avoid net deformation

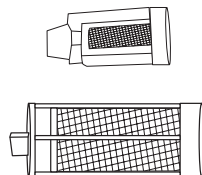

4

Reinstal l the net and others in turn.

Notice: tighten up the filter in special spanner, turn on the inlet valve to check it leakage or not.

● Long time no use

- ◆ Please turn off inlet valve and power supplier when out of house as long time or don't use it. Please don't turn off inlet valve and power when room temperature lower than 0°C, your bidet will enter anti-freeze program automatically.

● Daily wash

Disassemble and install

- 1、 Take out plug from socket.
- 2、 Turn off inlet valve.
- 3、 Grip the bidet to pull out, separate it with ceramic toilet.
- 4、 Clean surface of bidet and toilet.
- 5、 Reinstall it after clean bidet and toilet. Grip the bidet to slid it into bracket to hear a sound 'ka' means correct position.
- 6、 Make sure the bidet tight fit with the toilet.
- 7、 Turn off inlet valve and put plug into socket.



● Replace the remote control battery

- ◆ When the battery is running out, the remote control is sometimes insensitive and sometimes out of control and you should replace the battery at this point

※ Attention:

The positive and negative poles of the battery must be placed correctly , and the compression spring protrudes from the negative pole.
New and old batteries cannot be mixed.
Please use alkaline battery.

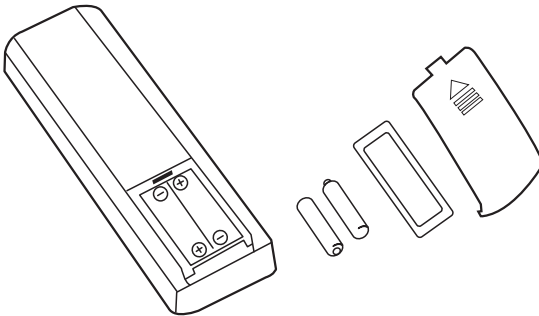

Appendix

Product specification

Rated voltage	<input type="checkbox"/> AC220V 50Hz	<input type="checkbox"/> AC220V 50Hz	<input type="checkbox"/> AC120V 60Hz	(Under the condition of 5℃ inlet water temp,maximum level of outlet water temp and strength) (Inlet water temp: 15℃±0.5℃)
Max power	1680W	1680W	1280W	
Rated power	1520W	1200W	1200W	
Power cord length	1.5m			
Cleansing and Flushing				
Water pressure range	0.06Mpa(dynamic)-0.75Mpa(Static)			
Water pressure adjustment	Adjustable in 4 levels			
Water Temp. Adjustment	Adjustable in 4 levels: 33℃, 36℃, 39℃, (Room Temperature)			
Safety Device	Temperature control system; Over-heated protection mechanism; Over-dried protection mechanism; water and electricity isolation system.			
General cleansing flow rates	0.5-0.9L/min(Minimum required water pressure:0.15Mpa)			
Feminine cleansing flow rates	0.5-0.9L/min(Minimum required water pressure:0.15Mpa)			
Seat Heating				
Surface temperature	Adjustable in 4 levels: 33℃, 36℃, 39℃ (Room Temperature)			
Safety device	Temperature control system; Over-heated protection mechanism			
Warm Air Dryer				
Warm air temperature	Adjustable in 4 levels from 32℃ to 52℃			
Safety Service	Temperature Reset Switch/Temperature fuse			
Deodorizer				
Method	Chemical absorption by deodorizer cartridge			

◆ Packing List ◆

Dear User:

Please check whether the products are complete after you open the box of toilet.

Product packaging box containing the items are:

- 1 toilet seat
- 1 manual
- 1 spanner
- 1 filter
- 1 rubber gasket
- 1 front wash nozzle(back up)
- 1 rear wash nozzle(backup)
- 1 PE inlet tube
- 1 fix bracket
- 2 metal gasket
- 2 mounting bolts
- 2 rubber sleeves
- 2 #7 Alkaline batteries

Warning

1. This appliance is not intended for use by persons (including children) with reduced physical, sensory or mental capabilities, or lack of experience and knowledge, unless they have been given supervision or instruction concerning use of the appliance by a person responsible for their safety.
2. Children should be supervised to ensure that they do not play with the appliance.
3. If the supply cord is damaged, it must be replaced by the manufacturer, its service agent or similarly qualified persons in order to avoid a hazard.

