

METAL GARDEN SHED 4X6FT

Instructions for Assembly

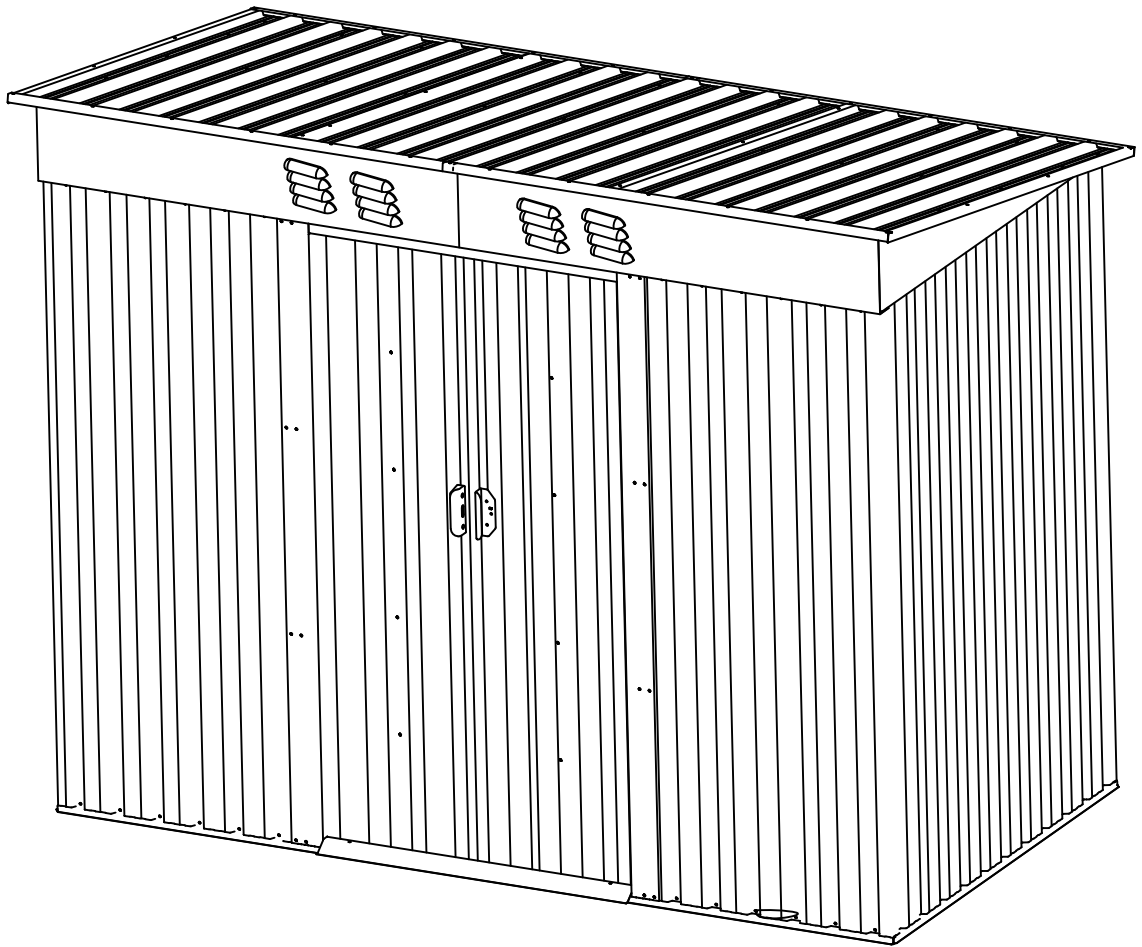

Requires two people and takes 2-3 hours for Installation.

WARNING

Please read the instruction manual carefully before assembly.
Please assembly strictly in accordance with the instruction.
Please double-check to ensure that all parts of the package contents intact.
To avoid injury work gloves are recommended during assembly.

BEFORE YOU BEGIN

Owner's Manual

Before beginning construction, check local building codes regarding footings, location and other requirements. Study and understand this owner's manual. Important information and helpful tips will make your construction easier and more enjoyable.

Assembly Instructions: Instructions are supplied in this manual and contain all appropriate information for your building model. Review all instructions before you begin, and during assembly, follow the step sequence carefully for correct results.

Parts and Parts List: Check to be sure that you have all the necessary parts, you're your building. Separate contents of the carton by the part number while reviewing parts list. The first few steps show how to join related parts to make larger sub assemblies which will be used later. Familiarize yourself with the hardware and fasteners for easier use during construction. These are packaged within the carton. Note that extra fasteners have been supplied for your convenience.

PLAN AHEAD

Watch the Weather: Be sure the day you select to install your building is dry and calm. Do not attempt to assemble your building on a windy day. Be careful on wet or muddy ground.

Teamwork: Whenever possible, two or more people should work together to assemble your building. One person can position parts or panels while the other is able to handle the fasteners and the tools.

Tools and Materials: These are some basic tools and materials you will need for the construction of your building. Decide which method of anchoring and the type of foundation you wish to use in order to form a complete list of the materials you will need.

CARE & MAINTENANCE

Finish: For long lasting finish, periodically clean and wax the exterior surface. Touch-up scratches as soon as you notice them on your unit. Immediately clean the area with a wire brush; wash it and apply touch-up paint per manufacturer's recommendation.

Roof: Keep roof clear of leaves and snow with long handled, soft-bristled broom. Heavy amounts of snow on roof can damage building making it unsafe to enter. In snow country, Roof Strengthening Kits are available for most Arrow Buildings for added protection against heavy snow accumulation.

Doors: Always keep the door tracks clear of dirt and other debris that prevent them from sliding easily. Lubricate door track annually with furniture polish or silicone spray. Keep doors closed and locked to prevent wind damage

Fasteners: Use all washers supplied to protect against weather infiltration and to protect the metal from being scratched by screws. Regularly check your building for loose screws, bolts, nuts, etc. and retighten them as necessary.

Moisture: A plastic sheet (vapor barrier) placed under the entire floor area with good ventilation will reduce condensation.

















Other Tips....

















Wash off inked part numbers on coated panels with soap and water.







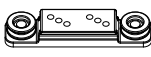

Silicone caulking may be used for watertight seals throughout the building.

Do not store swimming pool chemicals in your building. Combustibles and corrosives must be stored in air tight approved containers.

PARTS LIST

PART	NO.	Qty.
	1	1
	2	1
	3L	1
	3R	1
	4L	1
	4R	1
	5	1
	6	1
	7	1
	8	1
	9	1
	10L	1
	10R	1
	11	1
	12L	1
	12R	1
	15	2

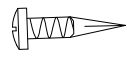
PART	NO.	Qty.
	17	4
	20	4
	21L	1
	21R	1
	25L	1
	25R	1
	27	2
	B1	4
	P1A	2
	P2	4
	P3	5
	P4	2
	P4A	2
	P5	2
	P6	1
	P7	2
	D1	1

PART	NO.	Qty.
	D2	1
	G2	4
	GB	2
	GC	4
	GD	4
	GF	2
	F1	184
	F2	55
	F3	8
	S1	108
	S2	228

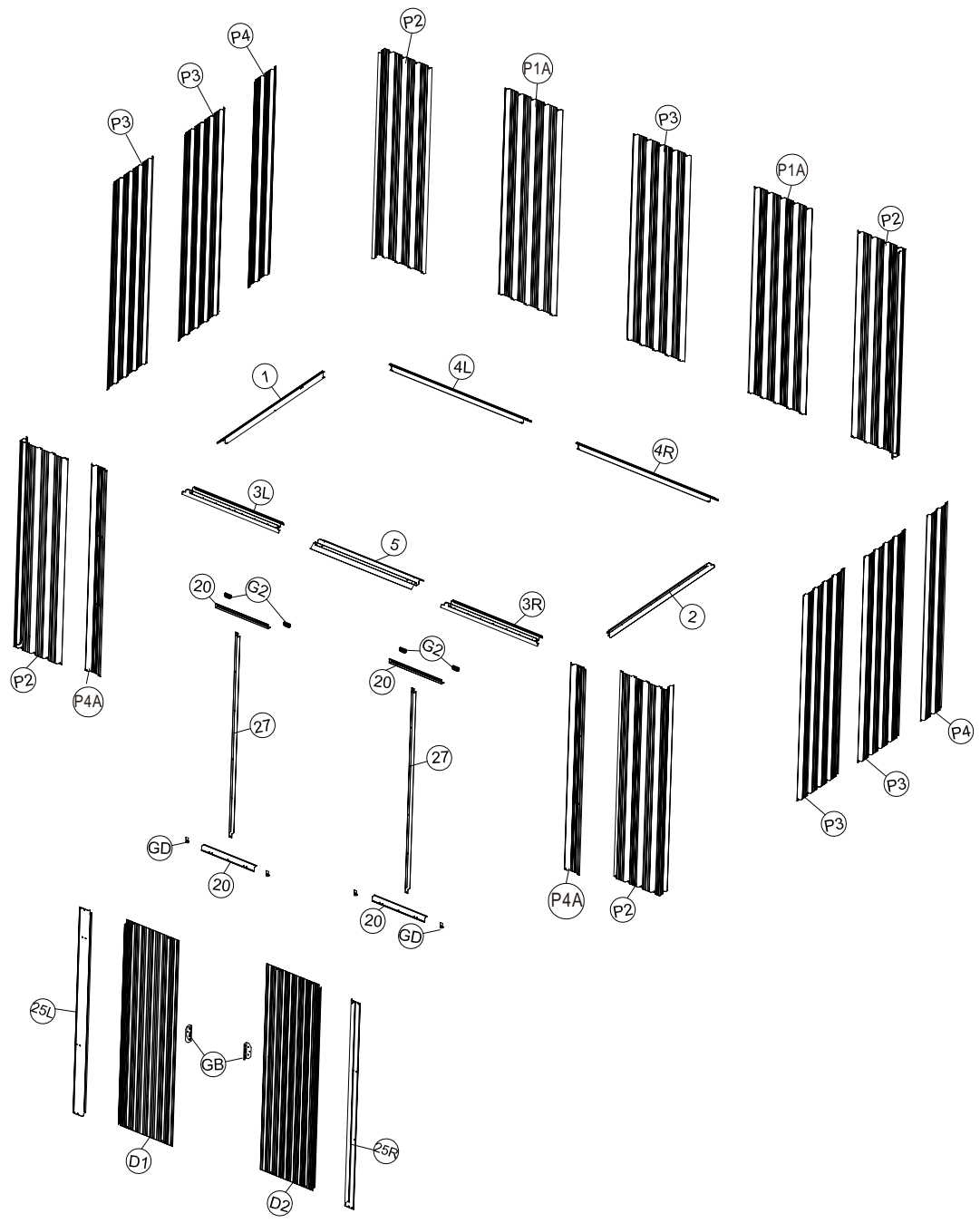
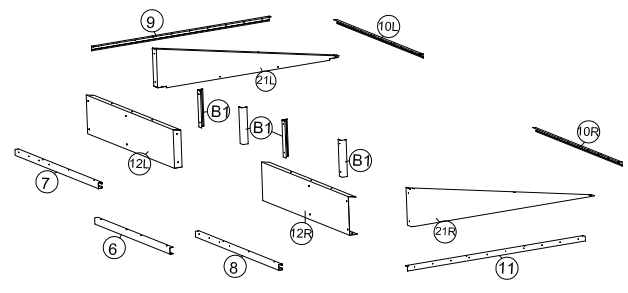
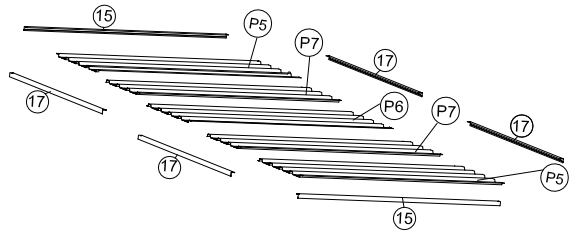







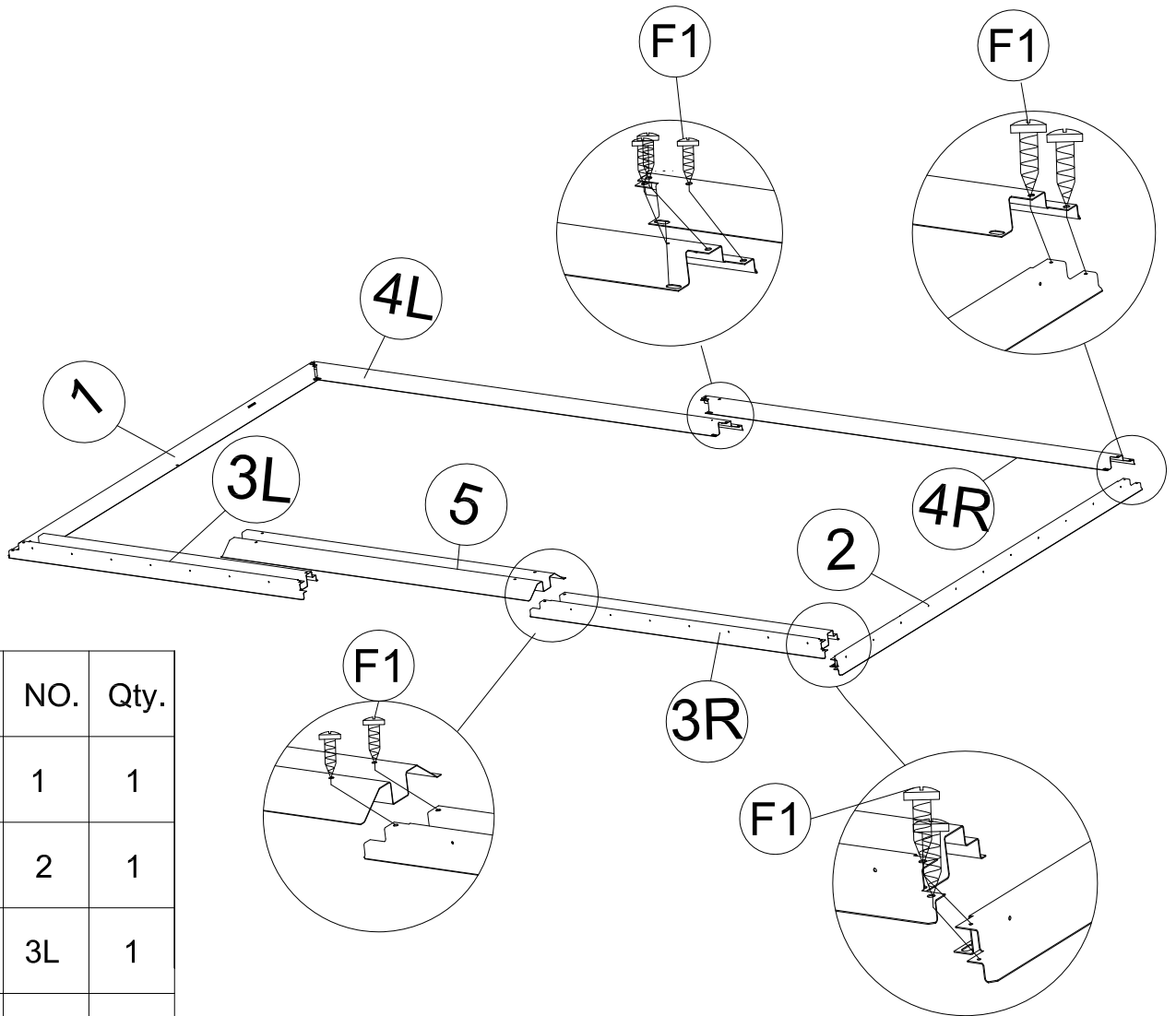

1

Assemble base bars from (1) to (4L) with (F1) Screws .
Then place the entrance taper channel (5)on top of the bar
(3L)and(3R).Secure with (F1) screws to the foundation.
Seeing the following figures .Make sure the base bar
assembly in a perfect square.





Note : Take care of sharp edges .

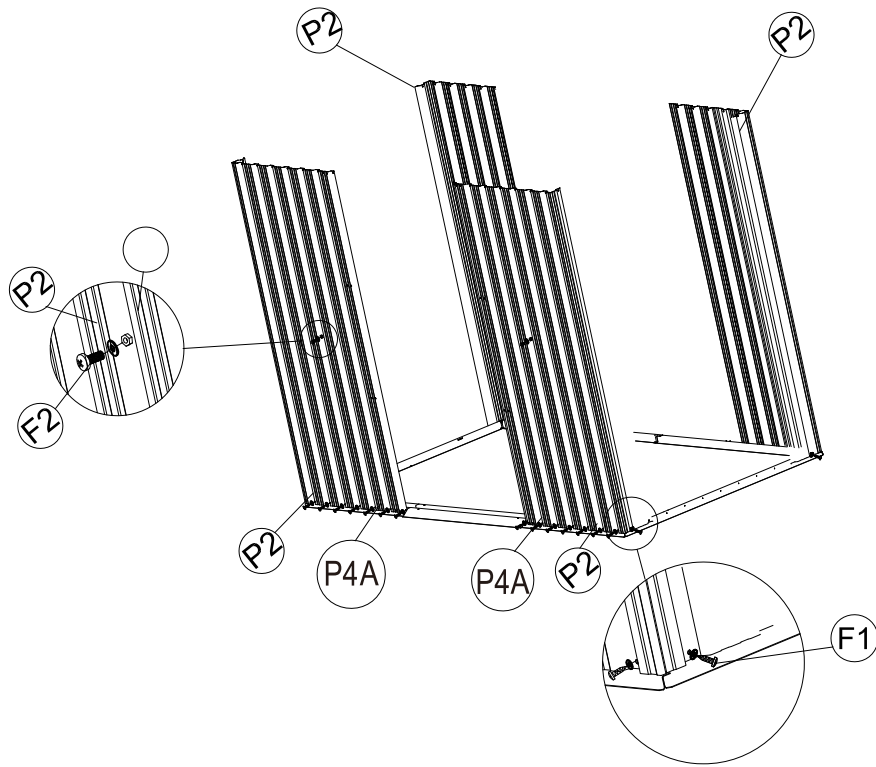

PART	NO.	Qty.
	1	1
	2	1
	3L	1
	3R	1
	4L	1
	4R	1
	5	1
	F1	16

2 Place the wall panel (P2),(P3) and (P4) on the base bars as showing Side wall of the shed line up the Holes With base bar. Secure with (F1). Screws with washers from outside.

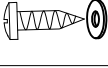
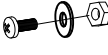

PART	NO.	Qty.
	P2	4
	P3	4
	P4	2
	P4A	2
	F1	20
	F2	15

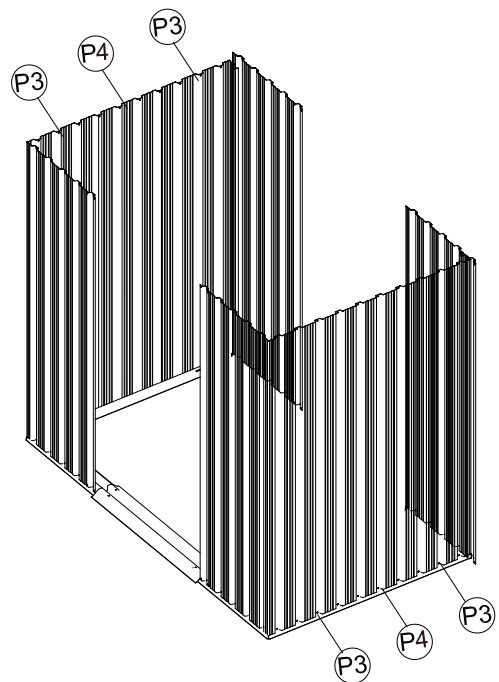

3

Insert the 2 pieces of (G2). Top slider into the Sliding channel (7) and (8). See blowup.

Assemble Door bar (6) between front wall panel (P1). And then place the sliding channel (7) and (8) on top of front wall panels from inside. Line up the holes with wall panel. Use (F1) screws with washers to fix. See the position in figures below .

Note: sliding channel (7) and (8) are not have holes. It's soft ,The screws easy can fix.

Note: Make sure the position of the projection On (G2) towards inside.

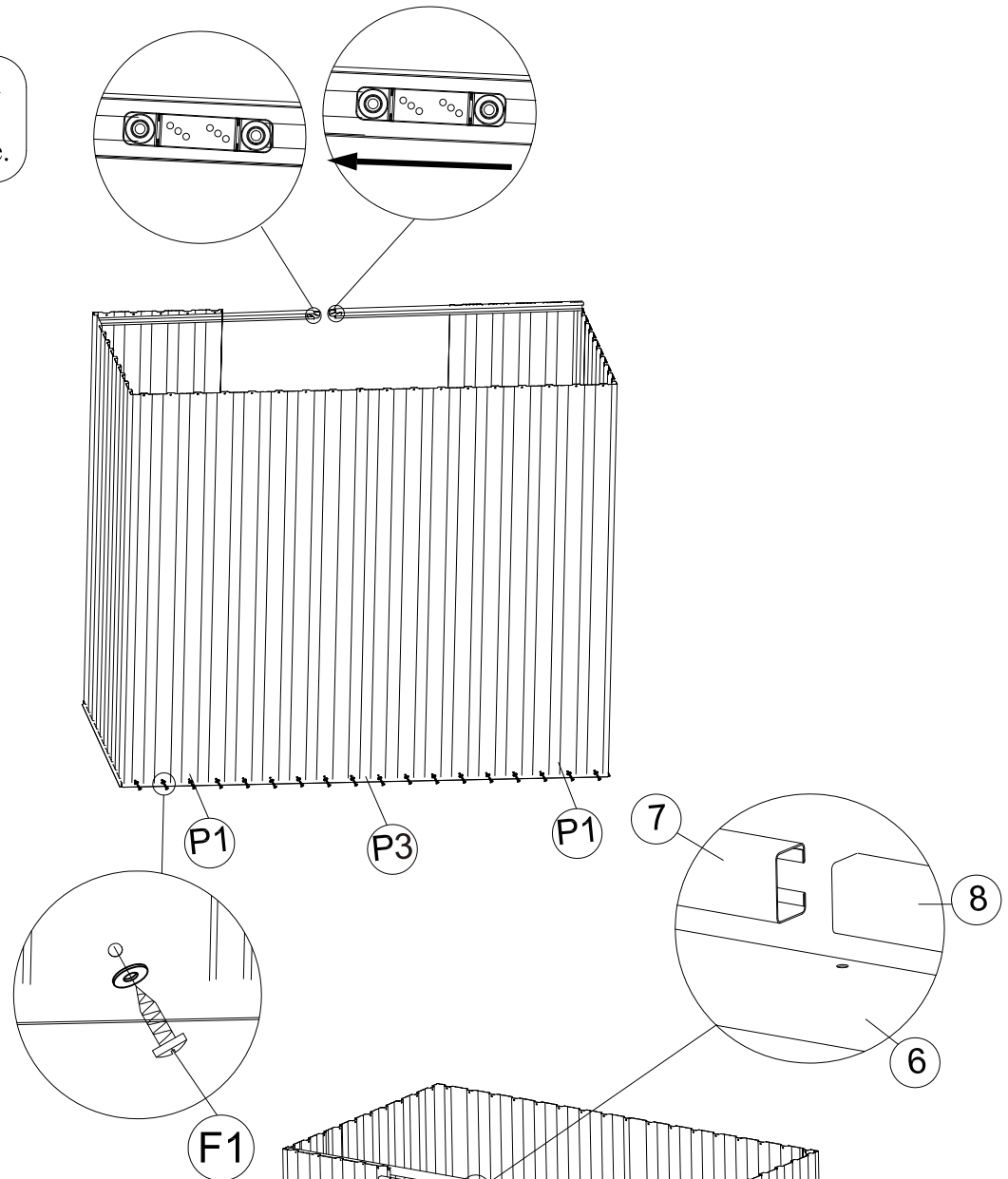

PART	NO.	Qty.
	6	1
	7	1
	8	1
	P1	2
	P3	1
	G2	4
	F1	28

4

Place the top angle bars (9),(10L) and (10R) on the top of wall panels as showing. Line up the holes with wall panels and fix with (F1) screws. Then place the wall panels (P1), (P2) and (P3) between the base bars and top angle bars. Secure them with (F1) screws with washers.

Note: Make sure the overlapping Position .

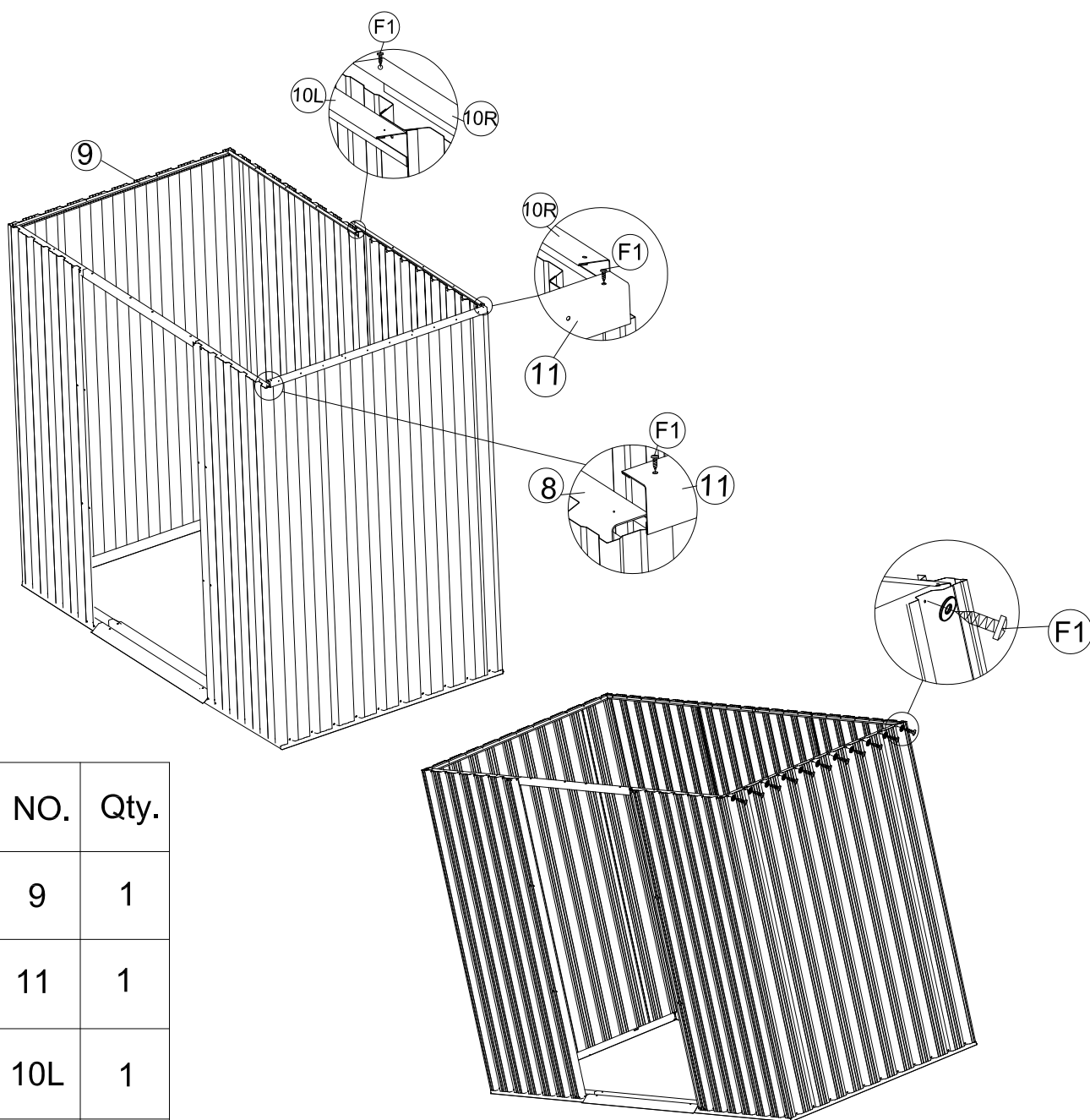



PART	NO.	Qty.
	9	1
	11	1
	10L	1
	10R	1
	F1	39

5

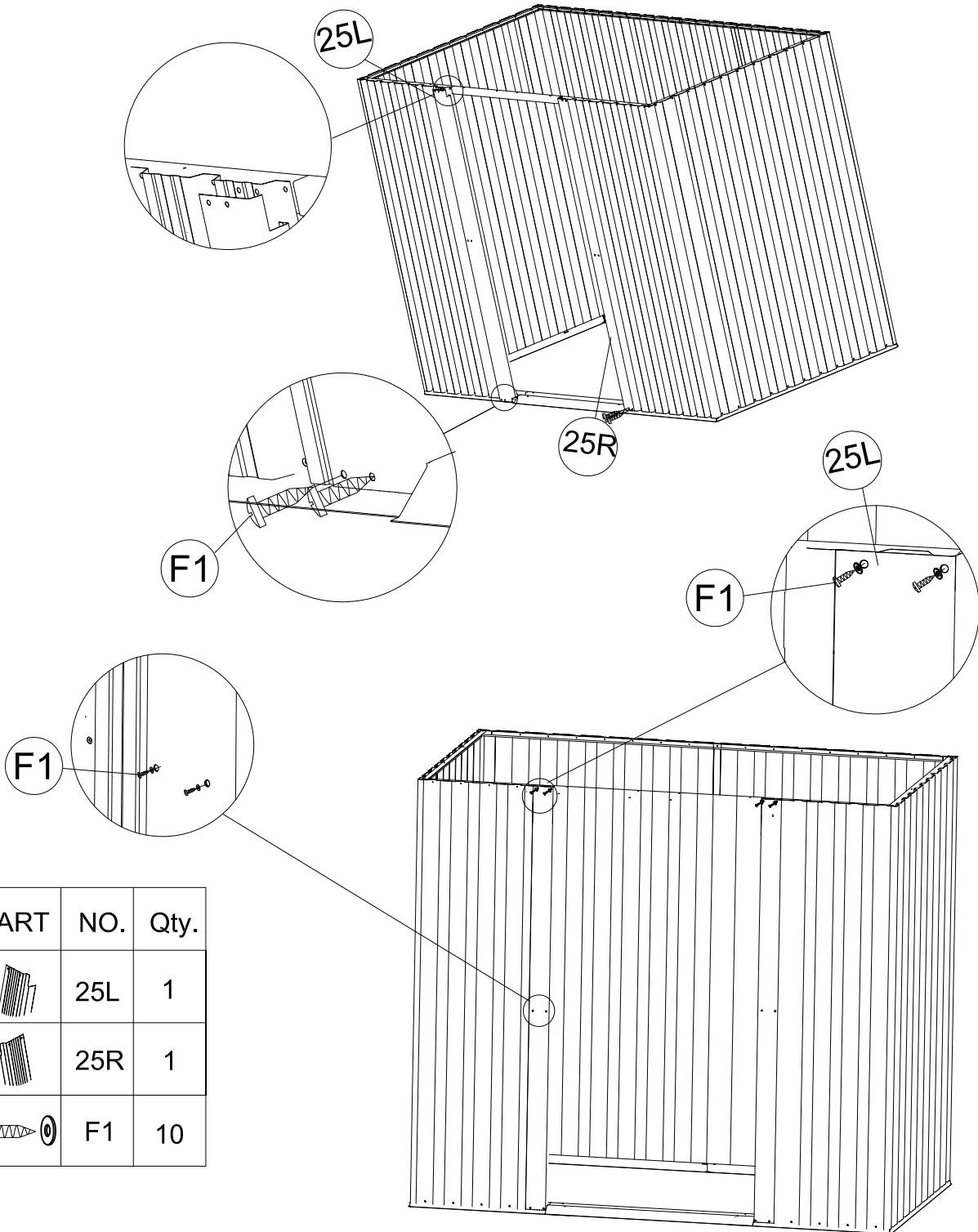
Place the left door column (25L) and (25R) on the top of basebar (3L) and (3R), Insert into the wall panel, Secure with (F1) screws.

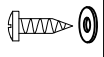

PART	NO.	Qty.
	25L	1
	25R	1
	F1	10

6

Place 2 piece of the Gable panel (12R) and (21R) each, on the top of the slide channel (6) and side top bar (9). Align the holes and secure them (F1) Screws from inside. Repeat the Same for the Gable panel (12L) and (21L). Then assemble 4 Galbe panels together with connector (F1) and assemble the connector (B1) as showed. Secure them with (F2) bolt and nut see figures below. Assemble the roof support to Gable panels (21L) and (21R), Align the boles and secure with (F1) screw.

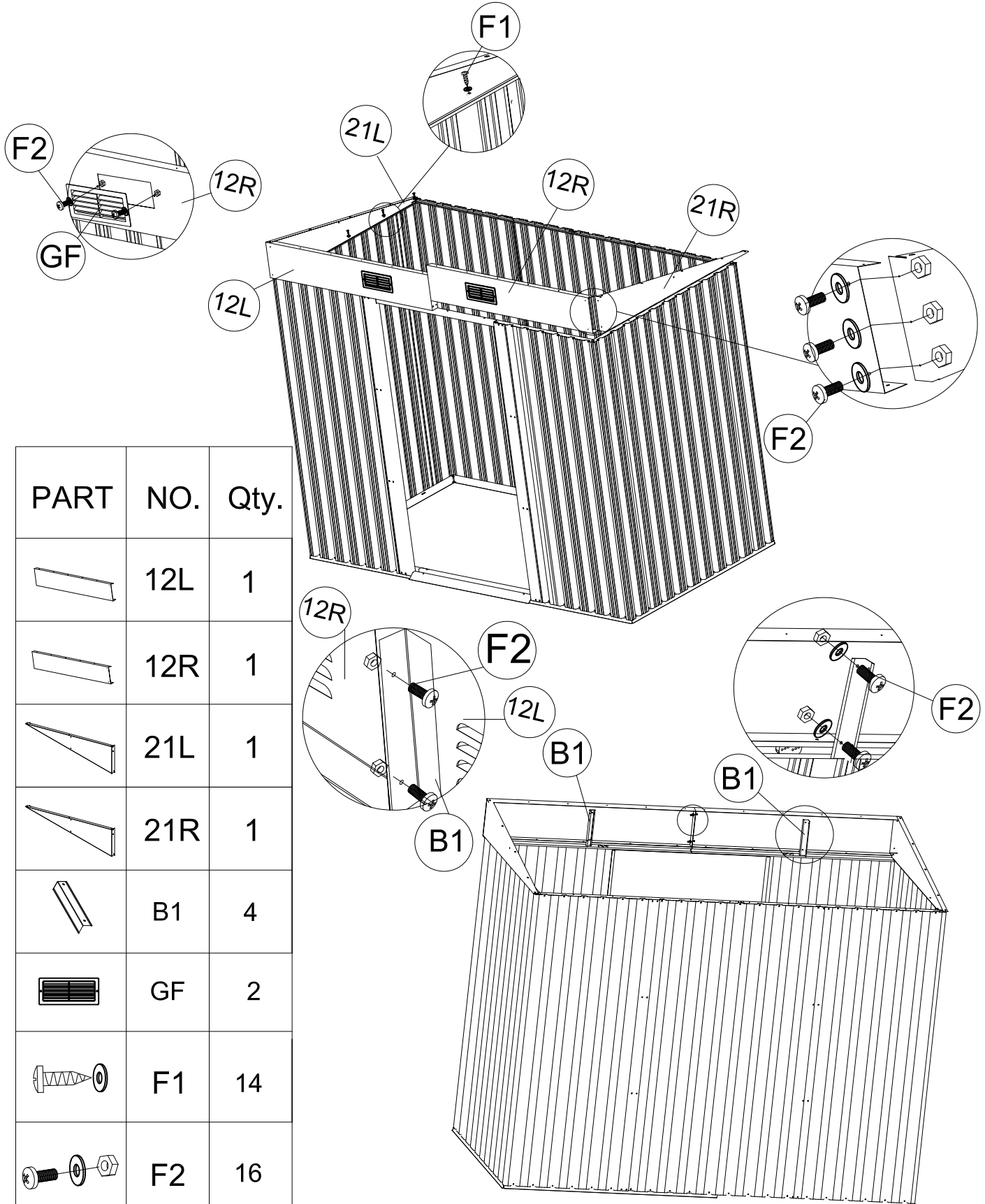



PART	NO.	Qty.
	12L	1
	12R	1
	21L	1
	21R	1
	B1	4
	GF	2
	F1	14
	F2	16

7

Place the roof panels (P5),(P6) and (P7)on the top of Gable panels and roof supports, Line up the boles and secure with (F1) bolt andnut with washers.

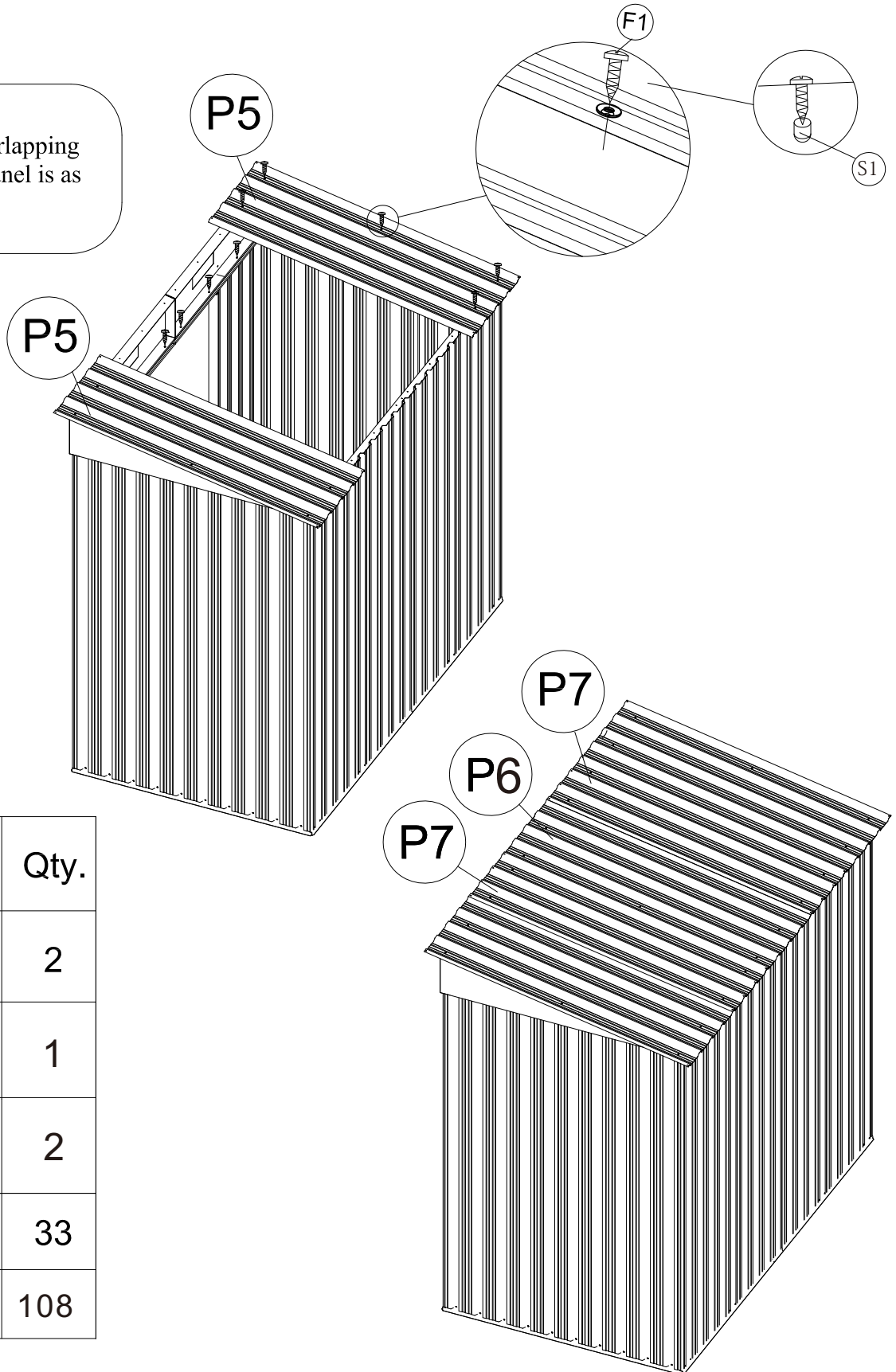
Note:
Make sure the overlapping position for roof panel is as shown in blowup.

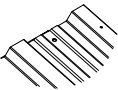
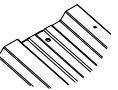
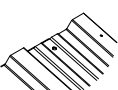
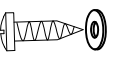



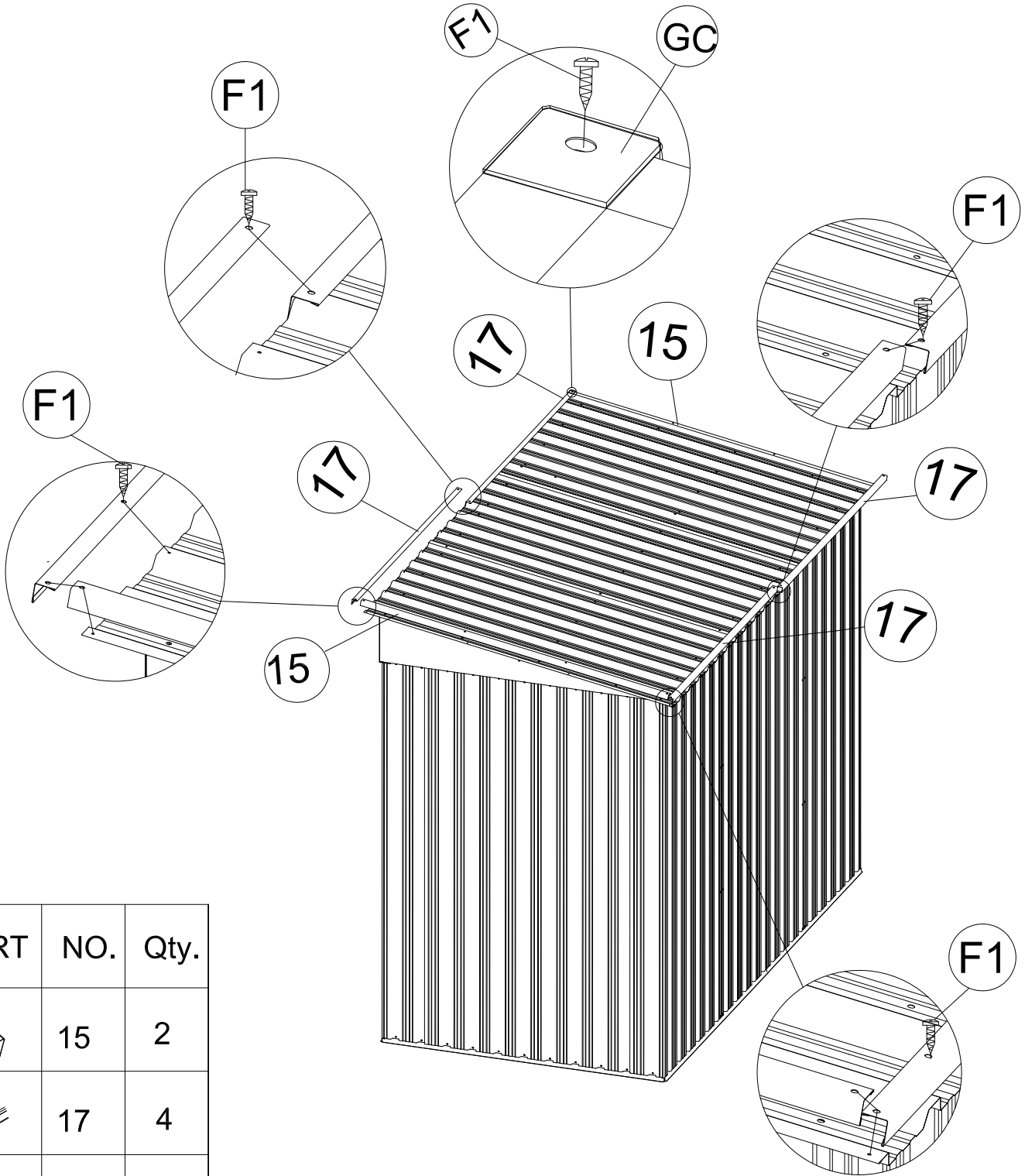

PART	NO.	Qty.
	P5	2
	P6	1
	P7	2
	F1	33
	S1	108

8

Assemble the roof flashing (15) and (17) with roof panels.
 Secure with (F1) screws with washers.
 Then place 4 piece of top corner (GC) on the roof
 Joints and secure with screws with washers.





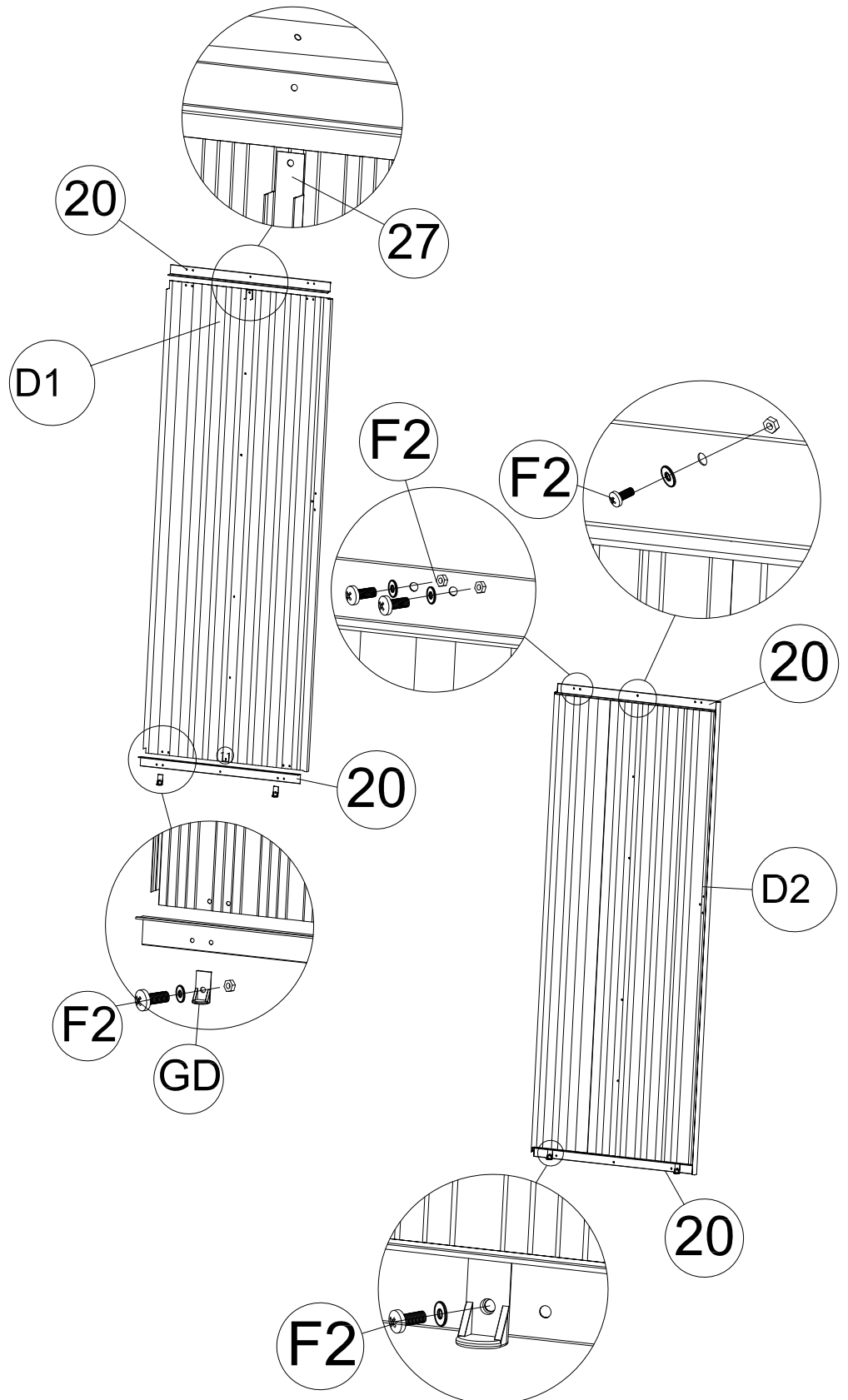

PART	NO.	Qty.
	15	2
	17	4
	GC	4
	F1	6

9

Assemble the door bar (20) to the door panels (D1) and (D2) and fix them with bar (27). Then assemble the bottom slider (GD) to the door bar (20) at both bottom edges. Secure them with (F2) bolt and nut with washer.

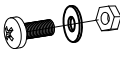

PART	NO.	Qty.
	27	2
	20	4
	D1	1
	D2	1
	GD	4
	F2	16

10

Fix 2 pieces of the door handle (D2) with door panels from inside with (F2) bolt and nut .

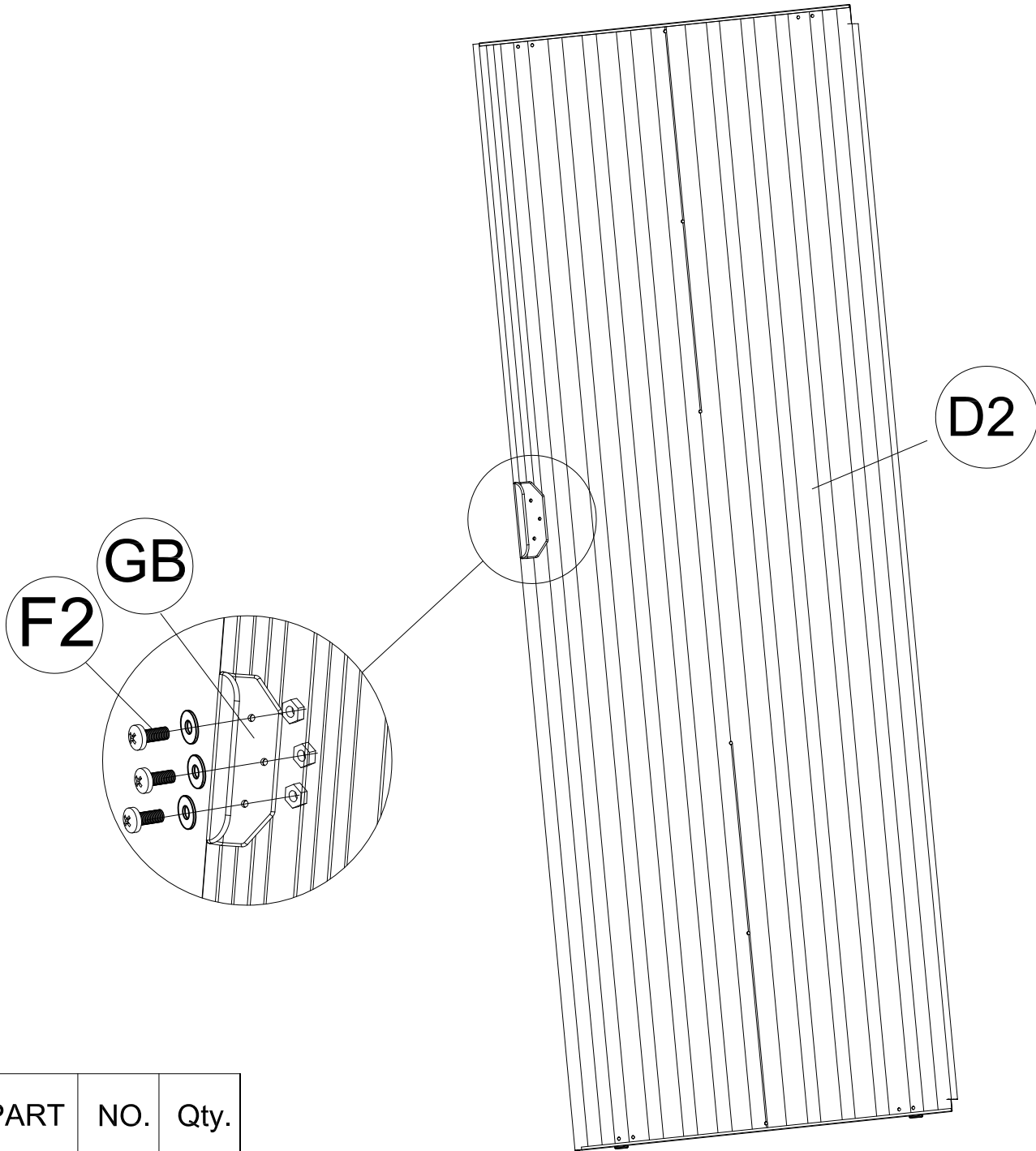

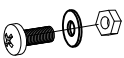
PART	NO.	Qty.
	GB	2
	F2	6

11

Slide the door panel assembly into the base bar (3L). Make sure the bottom slider (GD) should slide inside the base bar (3L), Then fix the door panel top to the top slider (G2) with (F3) screws. See figures below .

Note: Make sure to get proper alignment of the door realign the holes with door panel.

